

KOBELCO

HYDRAULIC CRAWLER CRANE
CKE600

Model: CKE600-1F

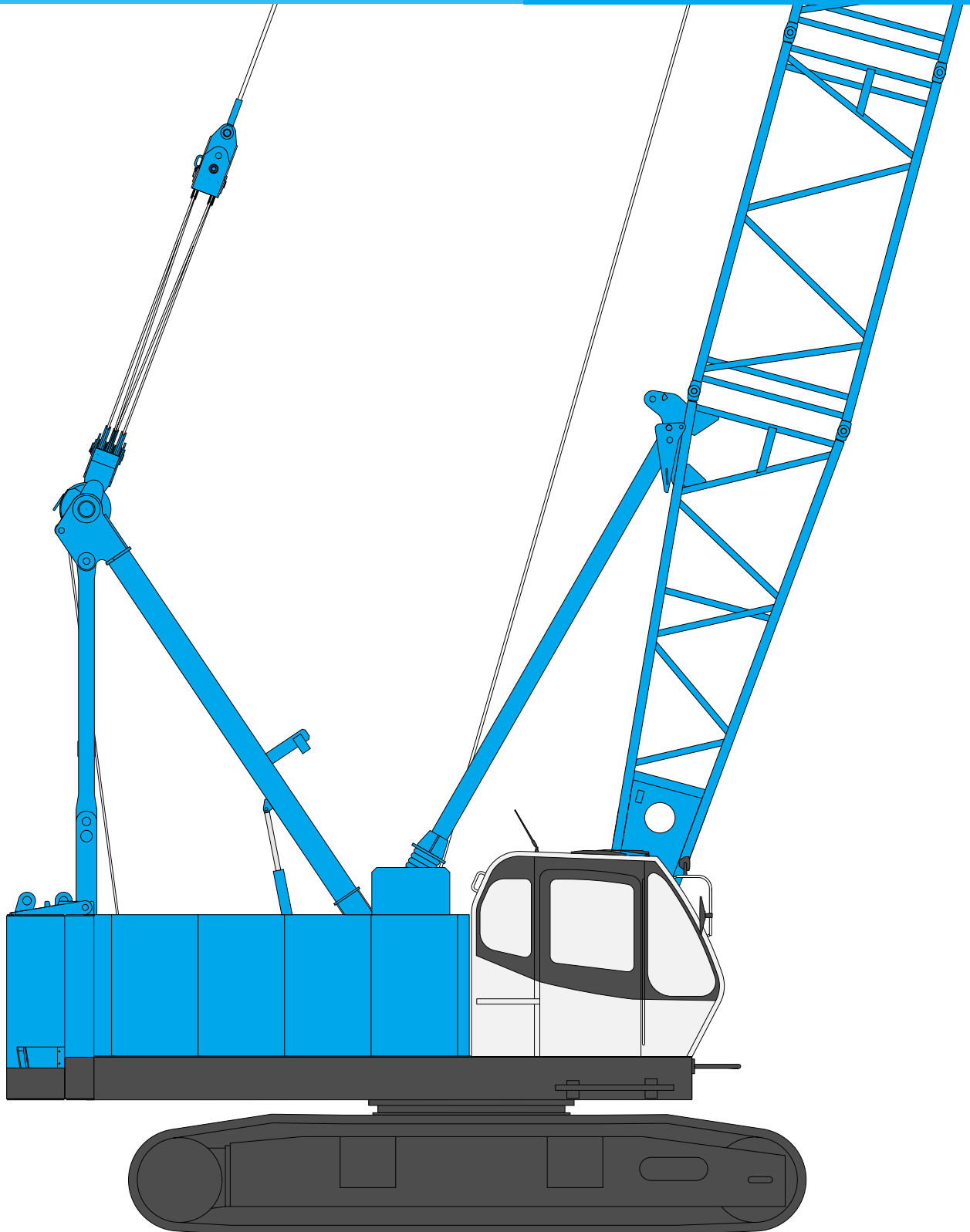

Max. Lifting Capacity: 60 t x 3.0 m
Max. Crane Boom Length: 51.8 m
Max. Fixed Jib Combination: 39.6 + 18.3 m
42.7 + 12.2 m

CONFIGURATION

Crane Boom

Max. Lifting Capacity:
60 metric ton x 3.0 m
Max. Boom Length:
51.8 m

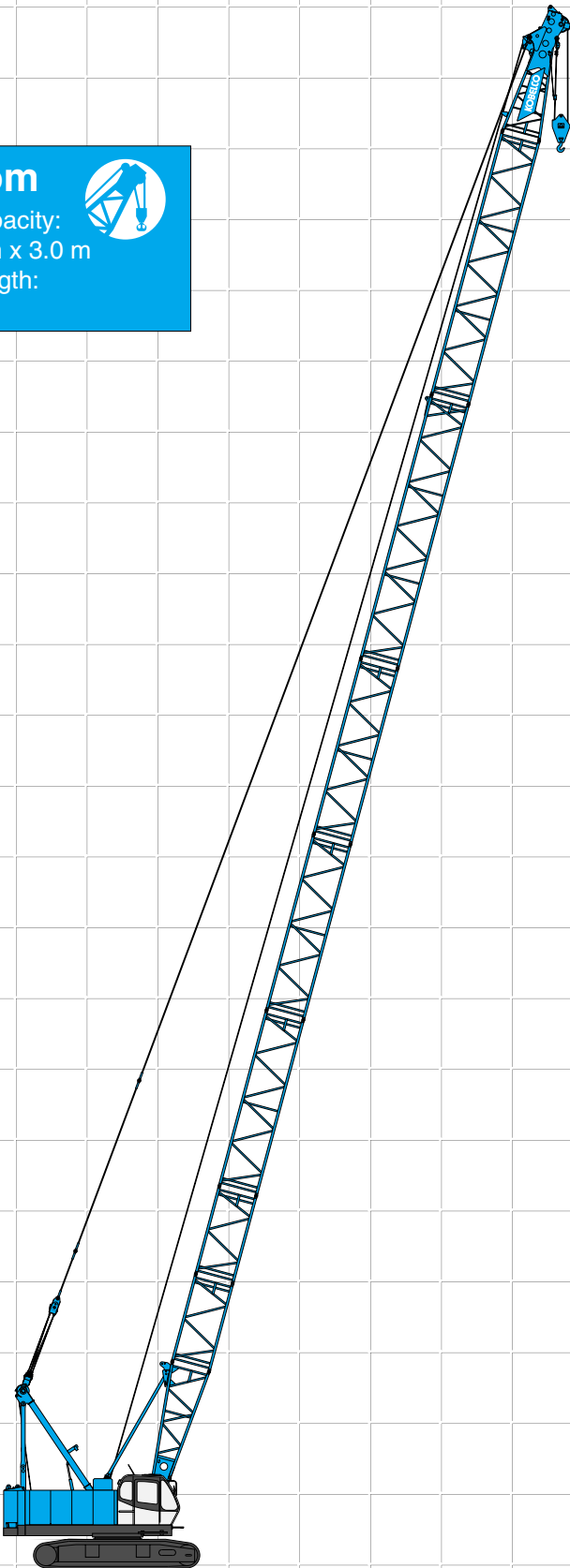

Fixed Jib



Max. Lifting Capacity:
6.6 metric ton x 16.0 m
Max. Combination:
42.7 m + 12.2 m
39.6 m + 18.3 m

Crane Boom with Fixed Jib



Max. Lifting Capacity:
19.4 metric ton x 6.6 m

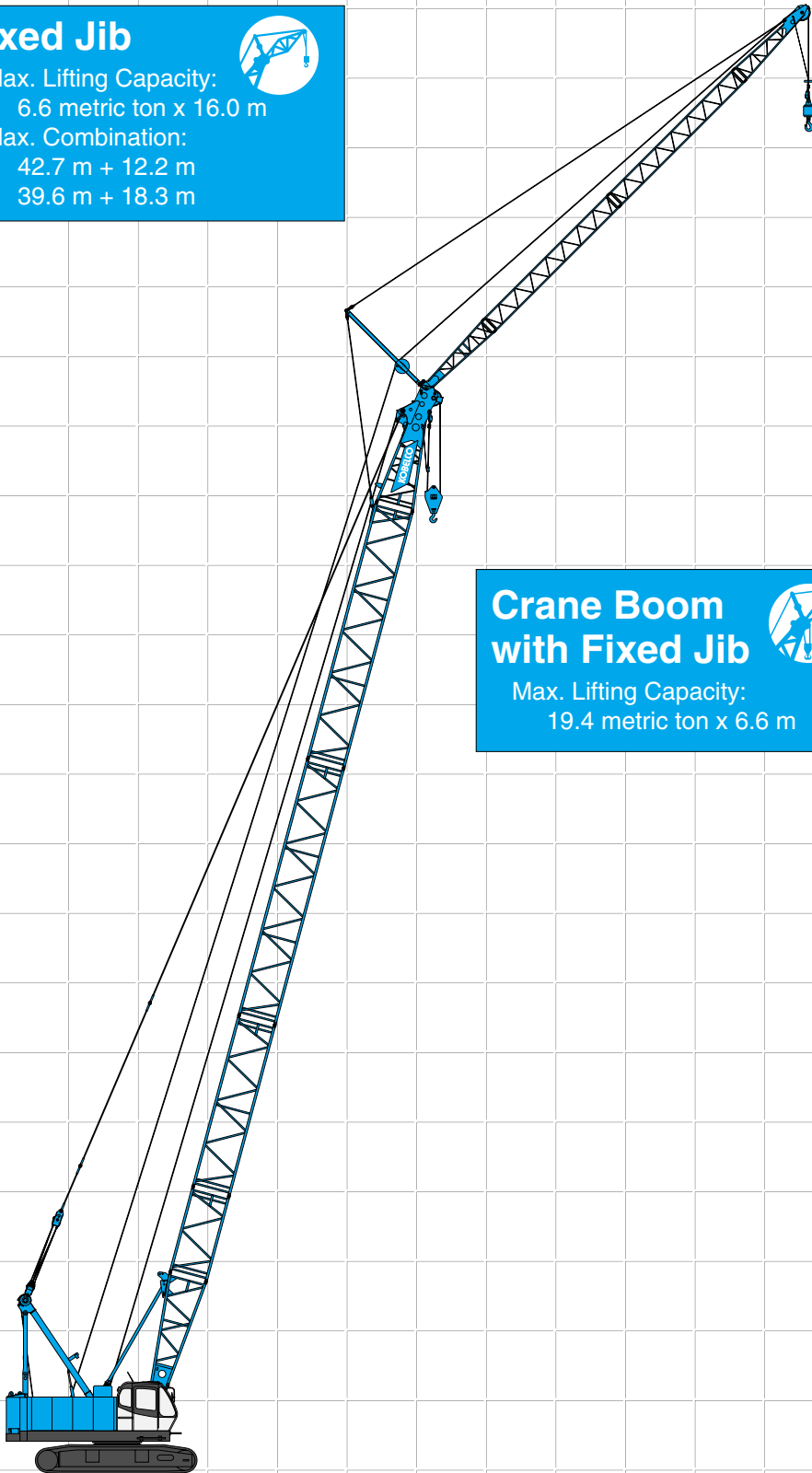

CONTENTS

Configuration	1
Specifications	3
General Dimensions	5
Boom and Jib Arrangements	
Crane Boom Arrangements	6
Fixed Jib Arrangements	6
Working Ranges and Lifting Capacities	
Crane Boom Working Ranges	8
Crane Boom Lifting Capacity	9
Auxiliary Sheave Lifting Capacity for Crane Boom	9
Fixed Jib Working Ranges	10
Fixed Jib Lifting Capacities	11
Crane Boom Lifting Capacity with Fixed Jib	13
Parts and Attachments ...	14

SPECIFICATIONS



Power Plant

Model: Hino diesel engine J08E-TM
Type: Water-cooled, direct fuel injection, with turbocharger
Complies with NRMM (Europe) Stage IIIA and US EPA TierIII.
Displacement: 7.684 liters
Rated Power: 159 kW at 2,000 min⁻¹ {rpm} (ISO)
Max. torque: 797 N·m/1,600 min⁻¹
Cooling system: Liquid, recirculating bypass
Starter: 24 V/5.0 kW
Radiator: Corrugated type core, thermostatically controlled
Air cleaner: Dry type with replaceable paper element
Throttle: Electric throttle control, twist grip type
Fuel filter: Replaceable paper element
Batteries: Two 12V, 150 Ah/20 HR capacity batteries, series connected.
Fuel tank capacity: 400 liters



Hydraulic System

Three variable displacement piston pumps are driven by heavy-duty pump drive. Two of variable displacement pumps are used in the main hook hoist circuit, boom hoist circuit, auxiliary hook hoist circuit, third hoist circuit and each propel circuit. The other is used in the swing circuit.

Control: Full-flow hydraulic control system for infinitely variable pressure to front and rear drums, boom hoist brakes and clutches. Controls respond instantly to the touch, delivering smooth function operation.

Cooling: Oil-to-air heat exchanger (plate-fin type)

Filtration: Full-flow and bypass type with replaceable element

Electrical system: All wiring corded for easy servicing, individual fused branch circuits.

Max. relief valve pressure:

Load hoist, boom hoist and propel system:

31.9 MPa {325 kgf/cm²}

Swing system: 27.5 MPa {280 kgf/cm²}

Control system: 7.0 MPa {71 kgf/cm²}

Reservoir capacity: 440 liters



Boom Hoisting System

Powered by a hydraulic motor through a planetary reducer.

Brake: A spring-set, hydraulically released multiple-disc brake is mounted on the boom hoist motor and operated through a counter-balance valve.

Drum lock: External ratchet for locking drum.

Drum: Single drum, grooved for 16 mm dia. wire rope.

Line speed: Single line on first drum layer

Hoisting/Lowering: 70 to 2 m/min

Diameter of wire ropes

Boom guy line: 30 mm

Boom hoist reeving: 12 parts of 16 mm dia. high strength wire rope

Boom backstops: Required for all boom lengths



Load Hoist System

Front and rear drums for load hoist powered by a hydraulic variable plunger motors, driven through planetary reducers.

Negative Brake: A spring-set, hydraulically released multiple-disc brake is mounted on the hoist motor and operated through a counter-balance valve. (Positive free fall brake is optional item.)

Drum lock: External ratchet for locking drum.

Drums:

Front drum:

550 mm P.C.D. x 545 mm wide drum, grooved for 22 mm wire rope. Rope capacity is 180 m working length and 335 m storage length.

Rear drum:

550 mm P.C.D. x 545 mm wide drum, grooved for 22 mm wire rope. Rope capacity is 130 m working length and 335 m storage length.

Note: Rope lengths listed above denote drum capacity and may differ from actual rope lengths supplied when machinery is shipped.

Line speed: Single line on the first drum layer

Hoisting/Lowering: 120 to 3 m/min

Line Pull (Single-line):

Rated line pull: 68.6 kN {7.0 tf}



Swing System

Swing unit is powered by hydraulic motor driving spur gear through planetary reducer, the swing system provides 360° rotation.

Swing parking brakes: A spring-set, hydraulically released multiple-disc brake is mounted on swing motor.

Swing circle: Single-row ball bearing with an integral internally cut swing gear.

Swing lock: Manually, two position lock for transportation

Swing speed: 4.0 min⁻¹ {rpm}



Upper Structure

Torsion-free precision machined upper frame. All components are located clearly and service friendly. Engine with low noise level. Complies with EC Directive 2000/14/EC.

Counterweight: 15.2 ton



Cab & Control

Totally enclosed, full vision cab with safety glass, fully adjustable, high backed seat with a head-rest and armrests, and intermittent wiper and window washer (roof and front window).

Cab fittings:

Air conditioner, convenient compartment (for tool), cup holder, ashtray, cigarette lighter, sun visor, roof blind, tinted glass, floor mat, foot-rest, shoe tray

Controls:

Four adjustable levers for front drum, rear drum, boom drum and swing controls, and boom hoist pedal.



Lower Structure

Steel-welded carbody with axles. Crawler assemblies can be hydraulically extended for wide-track operation or retracted for transportation. Crawler belt tension is maintained by hydraulic jack force on the track-adjusting bearing block.

Crawler drive: Independent hydraulic propel drive is built into each crawler side frame. Each drive consists of a hydraulic motor propelling a driving tumbler through a planetary gear box. Hydraulic motor and gear box are built into the crawler side frame within the shoe width.

Crawler brakes: Spring-set, hydraulically released parking brakes are built into each propel drive.

Steering mechanism: A hydraulic propel system provides both skid steering (driving one track only) and counter-rotating steering (driving each track in opposite directions).

Track rollers: Sealed track rollers for maintenance-free operation.

Shoes (flat): 59 shoes, 760 mm wide each crawler

Max. travel speed: 2.4/1.5 km/h

Max. gradeability (with basic boom): 40%



Weight

Including upper and lower machine, 15.2 ton counterweight basic boom (or basic jib), hook, and other accessories.

Specification	Weight	Ground pressure
Crane boom	Approx. 56.7 ton,	77.5 kPa {0.79 kgf/cm ² }
Fixed Jib	Approx. 59.3 ton,	81.0 kPa {0.83 kgf/cm ² }



Attachment

Boom and Jib:

Welded lattice construction using tubular, high-tensile steel chords with pin connections between sections.

Boom Length

	Crane Boom
Basic Boom	9.1 m
Max. Boom	51.8 m

Jib Length

	Fixed Jib
Basic Jib	6.1 m
Max. Jib	18.3 m

Max. Combination (Boom + Jib)

Crane Boom	51.8 m (boom only)
Fixed Jib	42.7 m + 12.2 m, 39.6 m + 18.3 m

Main Specifications (Model: CKE600-1F)

Crane Boom	
Max. Lifting Capacity	60 t/3.0 m
Max. Length	51.8 m
Fixed Jib	
Max. Lifting Capacity	6.6 t/16.0 m
Max. Combination	42.7 m + 12.2 m, 39.6 m + 18.3 m
Main & Aux. Winch	
Max. Line Speed	120 m/min (1st layer)
Rated Line Pull (Single line)	68.6 kN {7.0 tf}
Wire Rope Diameter	22 mm
Wire Rope Length	180 m (Main) 130 m (Aux.)
Brake Type	Spring set hydraulically released (Negative)
Free-Fall Brake Type	Wet-type multiple disc brake (Optional)
Working Speed	
Swing Speed	4.0 min ⁻¹ {rpm}
Travel Speed	2.4/1.5 km/h
Power Plant	
Model	Hino J08E-TM
Engine Output (Gross)	159 kW/2,000 min ⁻¹ {rpm}
Fuel Tank Capacity	400 liters

Hydraulic System	
Main Pumps	3 variable displacement
Max. Pressure	31.9 MPa {325 kgf/cm ² }
Hydraulic Tank Capacity	440 liters
Self-Removal Device	
Standard counterweight removal	
Weight	
Operating Weight*	Approx. 56.7 t
Ground Pressure	77.5 kPa {0.79 kgf/cm ² }
Counterweight	15.2 t
Transport Weight**	Approx. 40.5t

Units are SI units. { } indicates conventional units.

Line speeds in table are for light loads. Line speed varies with load.

* Including upper and lower machine, 15.2 ton counterweight, basic boom, hook, and other accessories.

** Base machine with main and aux. winch with wire rope (Refer to P14)

GENERAL DIMENSIONS

Crane Boom

(Unit: mm)

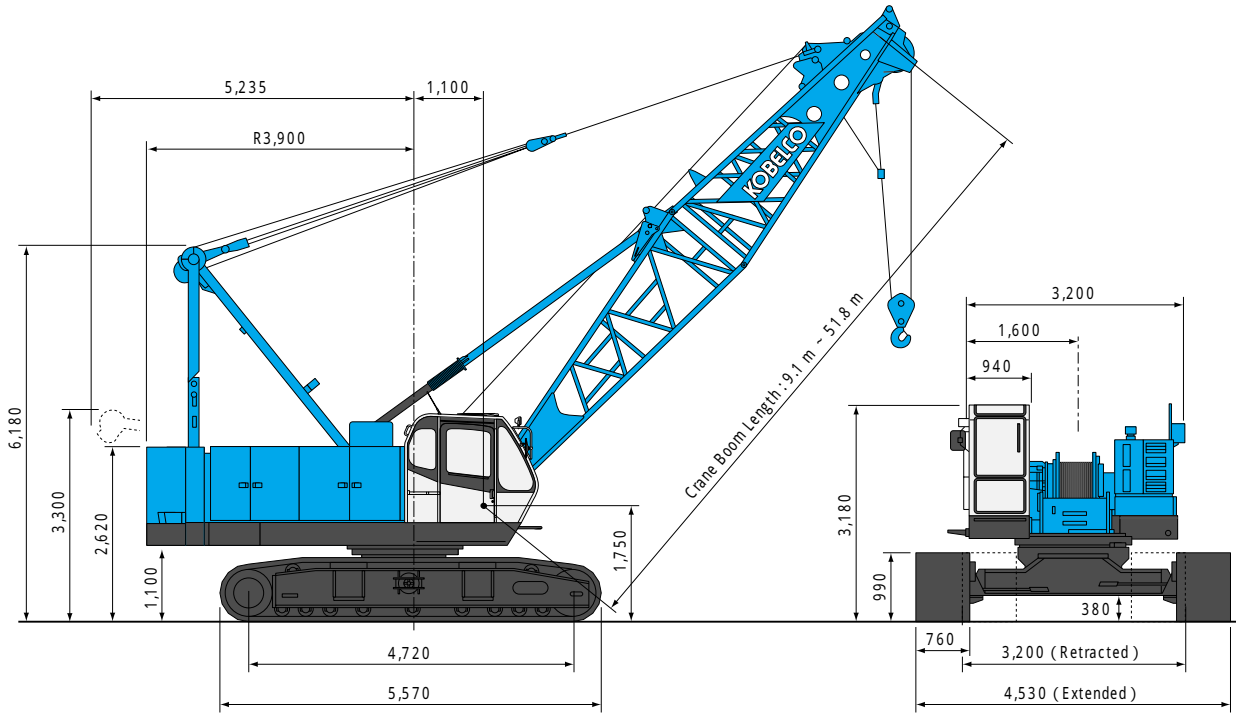

Limit of Hook Lifting

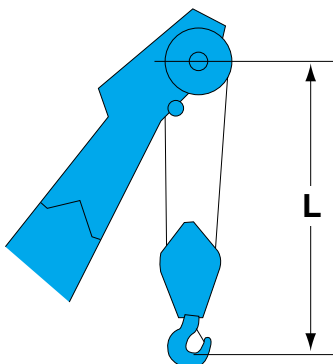

Hook	L
60 t hook	3.9 m
32 t hook	3.7 m
19 t hook	3.6 m

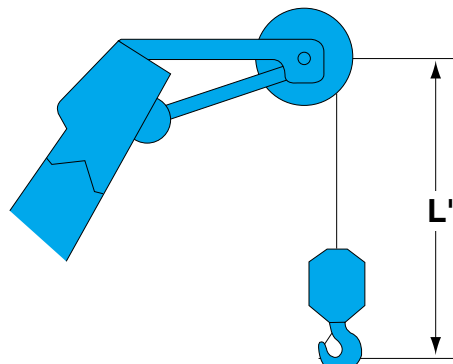

Hook	L'
6.6 t ball hook	3.0 m

BOOM AND JIB ARRANGEMENTS

Crane Boom Arrangements

Boom length m (ft)	Boom arrangement
9.1 (30)	
12.2 (40)	※
15.2 (50)	
	※
18.3 (60)	※
21.3 (70)	
	※
24.4 (80)	※
27.4 (90)	※
	※
30.5 (100)	
	※

Boom length m (ft)	Boom arrangement
33.5 (110)	
	※
36.6 (120)	※
39.6 (130)	
	※
42.7 (140)	※
45.7 (150)	※
48.8 (160)	※
51.8 (170)	※

Symbol	Boom Length	Remarks
	5.2 m	Boom Base
	3.9 m	Boom Top
	3.0 m	Insert Boom
	6.1 m	Insert Boom
	6.1 m	Insert Boom with lug
	9.1 m	Insert Boom
	9.1 m	Insert Boom with lug

↗ mark shows the guy line installing position when the fixed jib is used.

※ mark shows the standard boom arrangement which enables each boom length of less than that boom length to be configured.

Fixed Jib Arrangements

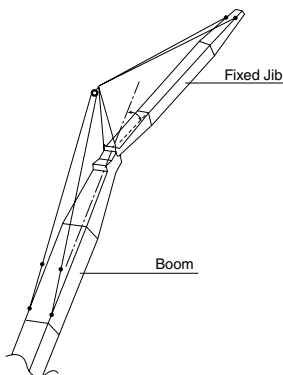

Crane boom length	Jib length m (ft)	Jib arrangement
30.5 m	6.1 (20)	
	12.2 (40)	
42.7 m	18.3 (60)	

Symbol	Jib Length	Remarks
	3.0 m	Jib Base
	3.0 m	Jib Top
	6.1 m	Insert Jib



Hook Blocks

A range of hook blocks can be specified, each with a safety latch.

Hooks	Weight (kg)	No. of sheaves	No. of lines and max. rated loads (tons)								
			1	2	3	4	5	6	7	8	9
60-ton	700	5	-	-	21.0	28.0	35.0	42.0	49.0	56.0	60.0
32-ton	500	2	-	14.0	21.0	28.0	32.0	-	-	-	-
19-ton	400	1	-	14.0	19.0	-	-	-	-	-	-
6.6-ton ball hook	160	0	6.6	-	-	-	-	-	-	-	-

Symbols for Attachments:



Crane Boom

Auxiliary Sheave
for Crane Boom

Fixed Jib

Crane Boom
with Fixed Jib

WORKING RANGES AND LIFTING CAPACITIES

Crane Boom Working Ranges

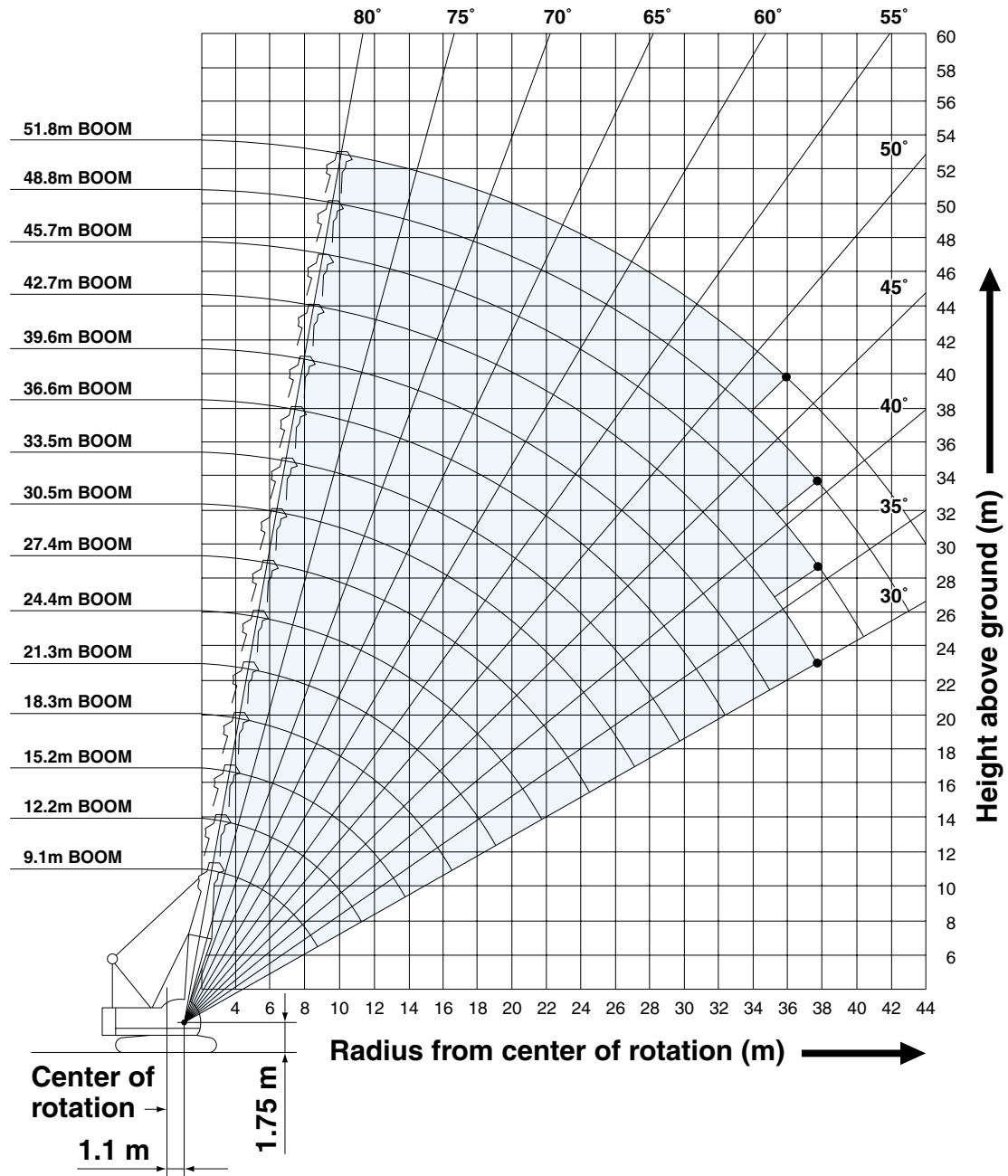

NOTES:

1. Ratings according to EN13000.
2. Ratings in metric tons for 360° working area.
3. Operating radius is the horizontal distance from center of rotation to a vertical line through the center of gravity of the load.
4. Weight of hook block (s), slings and other load handling accessories is included in rated load. Their total weight must be subtracted from rated load to obtain weight that can be lifted.
5. Ratings shown are based on freely suspended loads and make no allowance for such factors as wind effect on lifted load, ground conditions out-of-level, operating speeds or any other condition that could be detrimental to the safe operation of this equipment. Operator, therefore, has the responsibility to judge the existing conditions and reduce lifted loads and operating speeds accordingly.
6. Ratings are for operation on a firm and level surface, up to 1% gradient.
7. At radii and boom lengths where no ratings are shown on chart, operation is not intended nor approved.
8. Boom inserts and guy lines must be arranged as shown in the "Operator's Manual".
9. Boom hoist reeving is 12 part line.
10. Gantry must be in raised position for all conditions.
11. Boom backstops are required for all boom lengths.
12. Crawler frames must be fully extended for all boom lengths.
13. Ratings shown in are determined by the strength of the boom or other structural component.
14. Instruction in the "Operator's Manual" must be strictly observed when operating the machine.
15. Crane boom ratings: Deduct weight of main hook block, slings, and all other load handling accessories from crane boom ratings shown.
16. Auxiliary sheave ratings for crane boom: Deduct weight of ball hook, slings, and all other load handling accessories from auxiliary sheave ratings for crane boom shown.
17. Crane boom lengths for auxiliary sheave mounting are 9.1 m to 48.8 m.

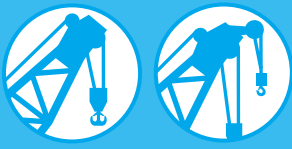

Crane Boom Lifting Capacity

Unit: metric ton

Counterweight: 15.2 t

Working radius (m) \ Boom Length (m)	Counterweight: 15.2 t															Working radius (m) \ Boom Length (m)		
	9.1	12.2	15.2	18.3	21.3	24.4	27.4	30.5	33.5	36.6	39.6	42.7	45.7	48.8	51.8			
3.0	60.0	3.5m/55.0															3.0	
4.0	50.7	50.7	46.5	4.5m/37.7													4.0	
5.0	38.5	38.4	37.4	32.4	31.5	5.6m/26.8											5.0	
6.0	28.7	28.6	28.4	27.1	25.9	24.8	6.1m/23.4	6.6m/20.5									6.0	
7.0	22.8	22.7	22.6	22.6	22.3	21.4	20.5	19.4									7.0	
8.0	18.9	18.8	18.6	18.6	18.5	18.1	17.4	16.8	16.1	15.6	8.2m/14.6	8.7m/13.2					8.0	
9.0	16.1	15.9	15.8	15.8	15.7	15.6	15.5	14.9	14.3	13.9	13.3	12.6	9.3m/12.0	9.8m/10.9			9.0	
10.0	9.1m/15.9	13.8	13.7	13.6	13.5	13.5	13.4	13.1	12.6	12.3	11.8	11.4	11.1	10.7	10.3m/9.9		10.0	
12.0		11.7m/11.2	10.7	10.7	10.6	10.5	10.4	10.4	10.2	10.0	9.6	9.3	9.0	8.7	8.3		12.0	
14.0			8.8	8.7	8.6	8.5	8.4	8.4	8.3	8.2	8.0	7.7	7.5	7.2	6.9		14.0	
16.0			14.4m/8.5	7.3	7.2	7.1	7.0	7.0	6.9	6.8	6.7	6.5	6.3	6.0	5.8		16.0	
18.0				17.0m/6.8	6.2	6.1	6.0	5.9	5.8	5.7	5.6	5.5	5.3	5.1	4.9		18.0	
20.0					19.7m/5.4	5.3	5.2	5.1	5.0	4.9	4.8	4.7	4.6	4.4	4.1		20.0	
22.0						4.6	4.5	4.4	4.3	4.2	4.1	4.0	3.9	3.8	3.5		22.0	
24.0							22.3m/4.5	4.0	3.9	3.8	3.7	3.6	3.4	3.4	3.0		24.0	
26.0								24.9m/3.8	3.4	3.3	3.2	3.1	3.0	2.9	2.8		26.0	
28.0									27.6m/3.1	3.0	2.8	2.7	2.5	2.4	2.2		28.0	
30.0										2.6	2.5	2.3	2.2	2.1	1.8		30.0	
32.0										30.2m/2.5	2.2	2.0	1.9	1.8	1.5		32.0	
34.0											32.9m/2.0	1.7	1.6	1.5	1.4		34.0	
36.0												35.5m/1.6	1.4	1.3	1.2	1.0		36.0
38.0													1.2	1.1	1.0			38.0
Reeves	9	8	7	6	5	4	4	3	3	3	3	2	2	2	2	2	2	Reeves

Note:
Ratings according to EN13000.
Refer to notes P8.

Auxiliary Sheave Lifting Capacity for Crane Boom (With 19t Main Hook)

Unit: metric ton

Counterweight: 15.2 t

Working radius (m) \ Boom Length (m)	Counterweight: 15.2 t															Working radius (m) \ Boom Length (m)		
	9.1	12.2	15.2	18.3	21.3	24.4	27.4	30.5	33.5	36.6	39.6	42.7	45.7	48.8				
5.0	6.6	6.6	6.6	5.1m/6.6	5.6m/6.6													5.0
6.0	6.6	6.6	6.6	6.6	6.6	6.2m/6.6	6.7m/6.6											6.0
7.0	6.6	6.6	6.6	6.6	6.6	6.6	6.6	7.2m/6.6										7.0
8.0	6.6	6.6	6.6	6.6	6.6	6.6	6.6	6.6	8.6m/6.6	8.6m/6.6	8.8m/6.6							8.0
9.0	6.6	6.6	6.6	6.6	6.6	6.6	6.6	6.6	6.6	6.6	6.6	9.3m/6.6	9.9m/6.6					9.0
10.0	6.6	6.6	6.6	6.6	6.6	6.6	6.6	6.6	6.6	6.6	6.6	6.6	6.6	10.4m/6.6				10.0
12.0		6.6	6.6	6.6	6.6	6.6	6.6	6.6	6.6	6.6	6.6	6.6	6.6	6.6	6.6			12.0
14.0		12.6m/6.6	6.6	6.6	6.6	6.6	6.6	6.6	6.6	6.6	6.6	6.6	6.6	6.6	6.6			14.0
16.0			15.3m/6.6	6.6	6.5	6.4	6.3	6.3	6.2	6.1	6.0	5.8	5.6	5.3				16.0
18.0				17.9m/6.5	5.5	5.4	5.3	5.2	5.1	5.0	4.9	4.8	4.6	4.4				18.0
20.0					4.9	4.6	4.5	4.4	4.3	4.2	4.1	4.0	3.9	3.7				20.0
22.0					20.6m/4.7	3.9	3.8	3.7	3.6	3.5	3.4	3.3	3.2	3.1				22.0
24.0						23.2m/3.8	3.3	3.2	3.1	3.0	2.9	2.7	2.7	2.5				24.0
26.0							25.8m/3.1	2.7	2.6	2.5	2.4	2.3	2.2	2.1				26.0
28.0								2.5	2.3	2.1	2.0	1.8	1.8	1.7				28.0
30.0								28.5m/2.4	1.9	1.8	1.6	1.5	1.4	1.3				30.0
32.0									31.1m/1.8	1.5	1.3	1.2	1.1	1.0				32.0
34.0										33.8m/1.3	1.0							34.0
Reeves	1	1	1	1	1	1	1	1	1	1	1	1	1	1	1	1	1	Reeves

Note:
Ratings according to EN13000.
Ratings shown in are determined by the strength of the boom or other structural components.
Refer to notes P8.

Fixed Jib Working Ranges

Jib Offset Angle: 10°, 30°

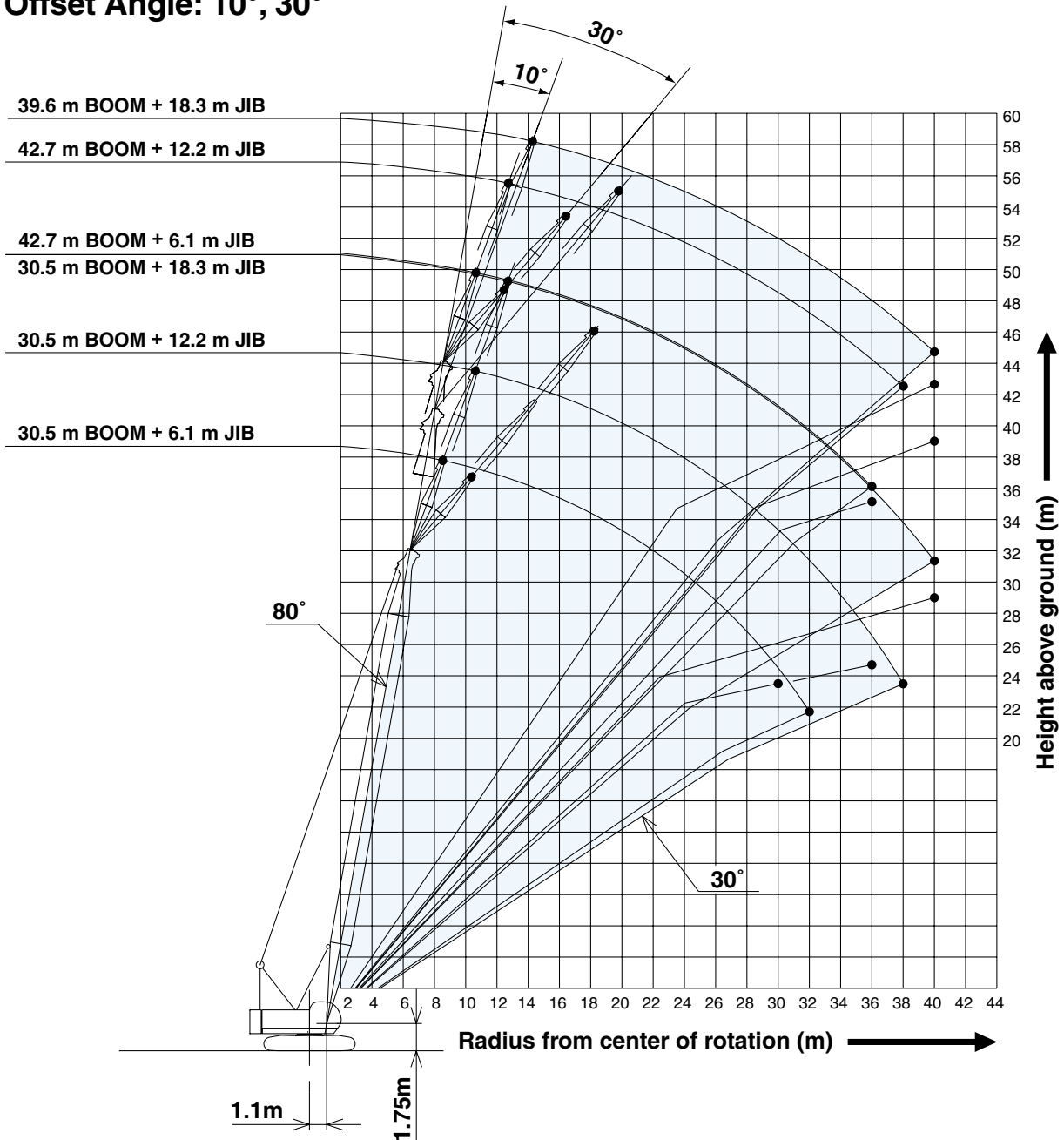

NOTES:

1. Ratings according to EN13000.
2. Ratings in metric tons for 360° working area.
3. Operating radius is the horizontal distance from center of rotation to a vertical line through the center of gravity of the load.
4. Weight of hook block (s), slings and other load handling accessories is included in rated load. Their total weight must be subtracted from rated load to obtain weight that can be lifted.
5. Ratings shown are based on freely suspended loads and make no allowance for such factors as wind effect on lifted load, ground conditions out-of-level, operating speeds or any other condition that could be detrimental to the safe operation of this equipment. Operator, therefore, has the responsibility to judge the existing conditions and reduce lifted loads and operating speeds accordingly.
6. Ratings are for operation on a firm and level surface, up to 1% gradient.
7. At radii and boom lengths where no ratings are shown on chart, operation is not intended nor approved.
8. Boom/ jib inserts and guy lines must be arranged as shown in the "Operator's Manual".
9. Boom hoist reeving is 12 part line.
10. Gantry must be in raised position for all conditions.
11. Boom backstops are required for all boom lengths.
12. Crawler frames must be fully extended for all boom lengths.
13. Ratings shown in are determined by the strength of the boom or other structural component.
14. Instruction in the "Operator's Manual" must be strictly observed when operating the machine.
15. Fixed jib ratings: Deduct weight of jib hook block, slings, and all other load handling accessories from fixed jib ratings shown.
16. Crane boom lengths for jib mounting are 30.5 m to 42.7 m.
17. Crane boom ratings with fixed jib: Deduct weight of jib hook block, slings, and all other load handling accessories from crane boom ratings with fixed jib shown.



Fixed Jib Lifting Capacities (Without Main Hook)

Jib Offset Angle: 10°

Unit: metric ton

Counterweight: 15.2 t

Boom length (m)	30.5			33.5			36.6			39.6			Boom length (m)	
Jib length (m)	6.1	12.2	18.3	6.1	12.2	18.3	6.1	12.2	18.3	6.1	12.2	18.3	Jib length (m)	
Working radius (m)	9.0	6.6		6.6						6.6			9.0	
	10.0	6.6		6.6			6.6			6.6			10.0	
	12.0	6.6	6.6	4.5	6.6	6.6		6.6	6.6		6.6		12.0	
	14.0	6.6	6.6	4.5	6.6	6.6	4.5	6.6	6.6	4.5	6.6	6.6	4.5	14.0
	16.0	6.6	6.6	4.5	6.6	6.6	4.5	6.6	6.6	4.5	6.6	6.6	4.5	16.0
	18.0	6.0	6.2	4.5	5.9	6.1	4.5	5.8	6.1	4.5	5.7	6.0	4.5	18.0
	20.0	5.1	5.3	4.5	5.0	5.2	4.5	4.9	5.2	4.5	4.8	5.1	4.5	20.0
	22.0	4.4	4.6	4.5	4.3	4.5	4.5	4.2	4.4	4.5	4.1	4.3	4.4	22.0
	24.0	3.8	4.0	4.1	3.7	3.9	4.0	3.7	3.9	3.9	3.5	3.8	3.8	24.0
	26.0	3.4	3.6	3.6	3.2	3.4	3.5	3.2	3.4	3.4	3.1	3.3	3.3	26.0
	28.0	3.0	3.1	3.2	2.8	3.0	3.1	2.8	3.0	3.0	2.7	2.8	2.9	28.0
	30.0	2.6	2.8	2.9	2.5	2.7	2.8	2.4	2.6	2.7	2.3	2.5	2.6	30.0
	32.0	2.3	2.5	2.6	2.2	2.4	2.5	2.1	2.3	2.4	1.9	2.2	2.3	32.0
	34.0		2.2	2.3	1.9	2.1	2.2	1.8	2.0	2.1	1.6	1.8	1.9	34.0
	36.0		2.0	2.1	1.6	1.8	1.9	1.5	1.7	1.8	1.3	1.6	1.7	36.0
	38.0		1.7	1.8		1.6	1.7	1.2	1.5	1.6	1.1	1.3	1.4	38.0
40.0			1.6		1.4	1.5		1.2	1.4		1.1	1.2	40.0	
Reeves	1	1	1	1	1	1	1	1	1	1	1	1	Reeves	

Boom length (m)	42.7		Boom length (m)
Jib length (m)	6.1	12.2	Jib length (m)
Working radius (m)	12.0	6.6	12.0
	14.0	6.6	14.0
	16.0	6.6	16.0
	18.0	5.6	18.0
	20.0	4.7	20.0
	22.0	4.0	22.0
	24.0	3.5	24.0
	26.0	3.0	26.0
	28.0	2.5	28.0
	30.0	2.1	30.0
	32.0	1.8	32.0
	34.0	1.5	34.0
36.0	1.2	36.0	
38.0		38.0	
Reeves	1	1	Reeves

Note:
 Ratings according to EN13000.
 Ratings shown in are determined by the strength of the boom or other structural components.
 Refer to notes P10.

Jib Offset Angle: 30°

Unit: metric ton

Counterweight: 15.2 t

Boom length (m)	30.5			33.5			36.6			39.6			Boom length (m)	
Jib length (m)	6.1	12.2	18.3	6.1	12.2	18.3	6.1	12.2	18.3	6.1	12.2	18.3	Jib length (m)	
Working radius (m)	12.0	6.6		6.6			6.6			6.6			12.0	
	14.0	6.6		6.6			6.6			6.6			14.0	
	16.0	6.6	5.0	6.6	5.0		6.6	5.0		6.6	5.0		16.0	
	18.0	6.2	5.0	3.2	6.1	5.0	3.2	6.0	5.0		5.9	5.0		18.0
	20.0	5.3	5.0	3.2	5.2	5.0	3.2	5.1	5.0	3.2	5.0	5.0	3.2	20.0
	22.0	4.5	4.9	3.2	4.4	4.8	3.2	4.4	4.7	3.2	4.3	4.7	3.2	22.0
	24.0	3.9	4.2	3.2	3.8	4.2	3.2	3.8	4.1	3.2	3.7	4.0	3.2	24.0
	26.0	3.4	3.7	3.2	3.3	3.6	3.2	3.3	3.6	3.2	3.2	3.5	3.2	26.0
	28.0	3.0	3.3	3.2	2.9	3.2	3.2	2.9	3.1	3.2	2.7	3.1	3.2	28.0
	30.0	2.7	2.9	3.1	2.6	2.8	3.0	2.5	2.8	3.0	2.4	2.7	2.9	30.0
	32.0		2.6	2.8	2.2	2.5	2.7	2.2	2.4	2.6	2.0	2.3	2.5	32.0
	34.0		2.3	2.5		2.2	2.4	1.8	2.1	2.3	1.7	2.0	2.2	34.0
	36.0		2.0	2.2		1.9	2.1		1.9	2.1	1.4	1.7	2.0	36.0
	38.0			2.0		1.7	1.9		1.6	1.8	1.1	1.5	1.7	38.0
	40.0			1.8			1.7		1.3	1.6		1.2	1.4	40.0
Reeves	1	1	1	1	1	1	1	1	1	1	1	1	Reeves	

Boom length (m)	42.7		Boom length (m)	
Jib length (m)	6.1	12.2	Jib length (m)	
Working radius (m)	14.0	6.6	14.0	
	16.0	6.6	16.0	
	18.0	5.9	4.6	18.0
	20.0	4.9	4.4	20.0
	22.0	4.2	4.3	22.0
	24.0	3.6	4.0	24.0
	26.0	3.1	3.4	26.0
	28.0	2.7	3.0	28.0
	30.0	2.3	2.6	30.0
	32.0	1.9	2.3	32.0
	34.0	1.6	1.9	34.0
	36.0	1.3	1.6	36.0
38.0		1.3	38.0	
40.0		1.1	40.0	
Reeves	1	1	Reeves	

Note:
 Ratings according to EN13000.
 Ratings shown in are determined by the strength of the boom or other structural components.
 Refer to notes P10.



Crane Boom Lifting Capacity with Fixed Jib

Unit: metric ton

Counterweight: 15.2 t

Boom length (m)	30.5			33.5			36.6			39.6			Boom length (m)	
Jib length (m)	6.1	12.2	18.3	6.1	12.2	18.3	6.1	12.2	18.3	6.1	12.2	18.3	Jib length (m)	
Working radius (m)	6.0	6.6m/19.4	6.6m/18.9	6.6m/18.4									6.0	
	7.0	18.3	17.8	17.3									7.0	
	8.0	15.7	15.2	14.7	15.0	14.5	14.0	14.5	14.0	13.5	8.2m/13.5	8.2m/13.0	8.2m/12.5	8.0
	9.0	13.8	13.3	12.8	13.2	12.7	12.2	12.8	12.3	11.8	12.2	11.7	11.2	9.0
	10.0	12.0	11.5	11.0	11.5	11.0	10.5	11.2	10.7	10.2	10.7	10.2	9.7	10.0
	12.0	9.3	8.8	8.3	9.1	8.6	8.1	8.9	8.4	7.9	8.5	8.0	7.5	12.0
	14.0	7.3	6.8	6.3	7.2	6.7	6.2	7.1	6.6	6.1	6.9	6.4	5.9	14.0
	16.0	5.9	5.4	4.9	5.8	5.3	4.8	5.7	5.2	4.7	5.6	5.1	4.6	16.0
	18.0	4.8	4.3	3.8	4.7	4.2	3.7	4.6	4.1	3.6	4.5	4.0	3.5	18.0
	20.0	4.0	3.5	3.0	3.9	3.4	2.9	3.8	3.3	2.8	3.7	3.2	2.7	20.0
	22.0	3.3	2.8	2.3	3.2	2.7	2.2	3.1	2.6	2.1	3.0	2.5	2.0	22.0
	24.0	2.8	2.3	1.8	2.7	2.2	1.7	2.6	2.1	1.6	2.5	2.0	1.5	24.0
	26.0	2.3	1.8	1.3	2.2	1.7	1.2	2.1	1.6	1.1	2.0	1.5	1.0	26.0
	28.0	27.6m/2.0	27.6m/1.5	27.6m/1.0	1.9	1.4		1.7	1.2		1.6	1.1		28.0
	30.0				1.5	1.0		1.4			1.2			30.0
32.0				30.2m/1.4			1.1						32.0	
Reeves	3	3	3	3	3	2	3	2	2	2	2	2	Reeves	

Boom length (m)	42.7		Boom length (m)	
Jib length (m)	6.1	12.2	Jib length (m)	
Working radius (m)	8.0	8.7m/12.1	8.7m/11.6	8.0
	9.0	11.5	11.0	9.0
	10.0	10.3	9.8	10.0
	12.0	8.2	7.7	12.0
	14.0	6.6	6.1	14.0
	16.0	5.4	4.9	16.0
	18.0	4.4	3.9	18.0
	20.0	3.6	3.1	20.0
	22.0	2.9	2.4	22.0
	24.0	2.3	1.8	24.0
	26.0	1.9	1.4	26.0
28.0	1.4		28.0	
30.0	1.1		30.0	
Reeves	2	2	Reeves	

Note:
Ratings according to EN13000.
Refer to notes P10.

PARTS AND ATTACHMENTS

Dimensions: mm, Weight: kg

Base Machine

With main and aux. winches including wire rope
Weight: 40,500 kg Width: 3,200 mm

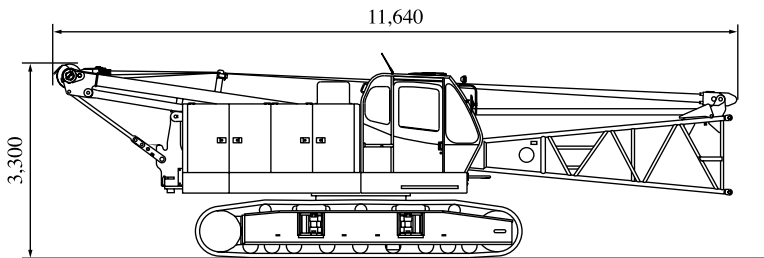

Base Machine

With main and aux. winches including wire rope
Weight: 38,500 kg Width: 3,200 mm

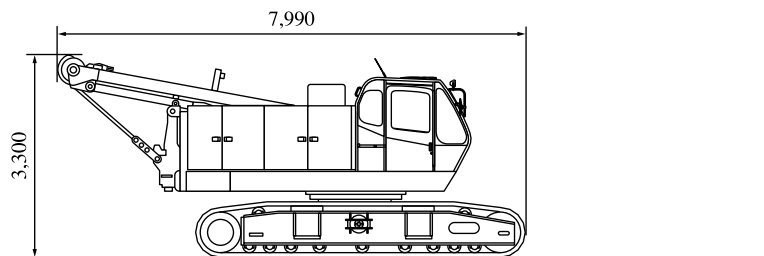

Boom Top (with guy cables)

Weight: 1,060 kg

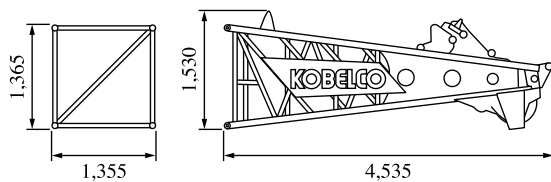

Counterweight A

Weight: 9,000 kg

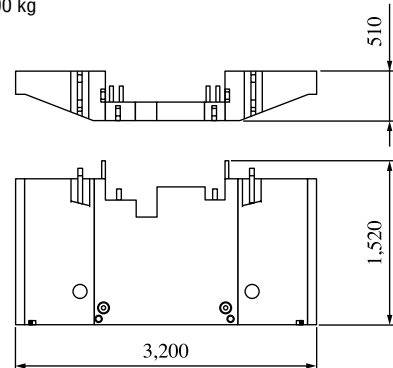

Counterweight B

Weight: 6,200 kg

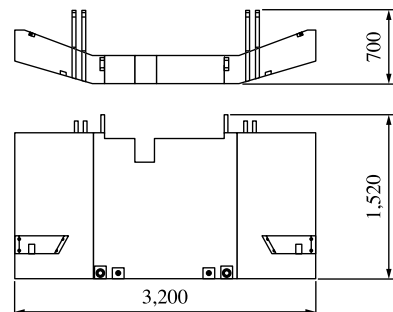

Boom Base

Weight: 980 kg

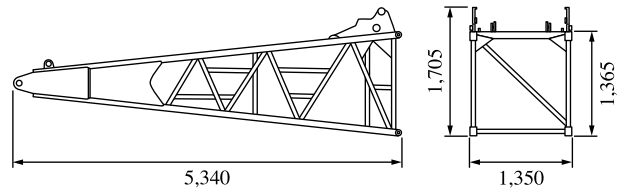

Other Attachments

Attachment	Weight	Dimensions (L x W x H)
3.0 m insert boom	305 kg (with guy cables)	3,160 mm x 1,365 mm x 1,365 mm
6.1 m insert boom	500 kg (with guy cables)	6,210 mm x 1,365 mm x 1,365 mm
6.1 m insert boom with lug	520 kg (with guy cables)	6,210 mm x 1,365 mm x 1,500 mm
9.1 m insert boom	710 kg (with guy cables)	9,260 mm x 1,365 mm x 1,365 mm
9.1 m insert boom with lug	730 kg (with guy cables)	9,260 mm x 1,365 mm x 1,500 mm
Jib top	145 kg	3,475 mm x 675 mm x 625 mm
Jib base	125 kg	3,190 mm x 675 mm x 625 mm
6.1 m insert jib	165 kg (with guy cables)	6,160 mm x 675 mm x 625 mm
Strut	190 kg	3,700 mm x 670 mm x 500 mm
Auxiliary sheave	140 kg	1,010 mm x 1,310 mm
Upper spreader	280 kg	680 mm x 1,580 mm x 300 mm
Crawler	6,500 kg	5,570 mm x 760 mm x 1,010 mm
6.6-ton ball hook	160 kg	815 mm x 300 mm dia.
19-ton hook block	400 kg	590 mm x 385 mm x 1,270 mm
32-ton hook block	500 kg	590 mm x 330 mm x 1,530 mm
60-ton hook block	700 kg	650 mm x 480 mm x 1,570 mm

Note: Estimated weights may vary ± 2%

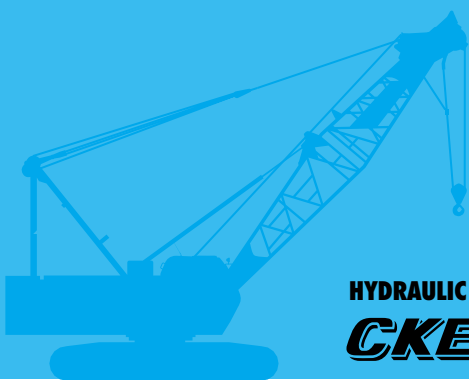

HYDRAULIC CRAWLER CRANE
CKE600

Standard Equipment

Upper structure/Lower structure

Counterweight: 15.2 ton (total weight)
760 mm shoe crawlers
Batteries (150 Ah/20HR)
Travel kit
Gantry raising/lowering cylinder
Electric hand throttle grip
Variable boom hoist speed controller
Side deck for cab
Steps (crawlers)
Two front working lights
Upper spreader storage guide
Tools (for routine maintenance)
Two rear view mirrors
Mirror for monitoring drums
Cable roller (for boom)
Tool box (front of left-side guard)

Cab/Control

Boom hoist pedal
Air conditioner
Cup holder
Ashtray
Cigar lighter
Intermittent wiper & window washer
(skylight and front window)
Sun visor
Roof blind
Floor mat (cloth)
Foot rest
Shoe tray
Level gauge (operator cabin)

Safety Device

Load Moment Indicator (with boom lowering slow stop function)
LMI release key (for hook over-hoist prevention device
and boom over-hoist prevention device)
LCD multi display
Ultimate stop function for boom over-hoist
Function lock lever
Propel lever lock
Mechanical drum lock pawl (main, aux. and boom hoist)
Signal horn
Swing parking brake
Mechanical swing lock pin (two positions)
Swing flashers/warning buzzer
Cab window guard (left side)
Cab top guard
Fire extinguisher
External lamp for over-load alarm
Life hammer

Note: Standard equipment may vary depending on your areas or countries.

Due to our policy of continual product improvements all designs and specifications are subject to change without advance notice.

Copyright by KOBELCO CRANES CO., LTD. No part of this catalog may be reproduced in any manner without notice.



KOBELCO CRANES CO., LTD.

17-1, Higashigotanda 2-chome, Shinagawa-ku, Tokyo 141-8626 JAPAN
Tel: +81-3-5789-2130 Fax: +81-3-5789-3372

Inquiries To:

KOBELCO is the corporate mark used by Kobe Steel on a variety of products and in the names of a number of Kobe Steel Group companies.