

**HEAVY DUTY BASE MACHINE
FOR FOUNDATION WORK**

BM800HD

KOBELCO

Model: BM800HD-2F

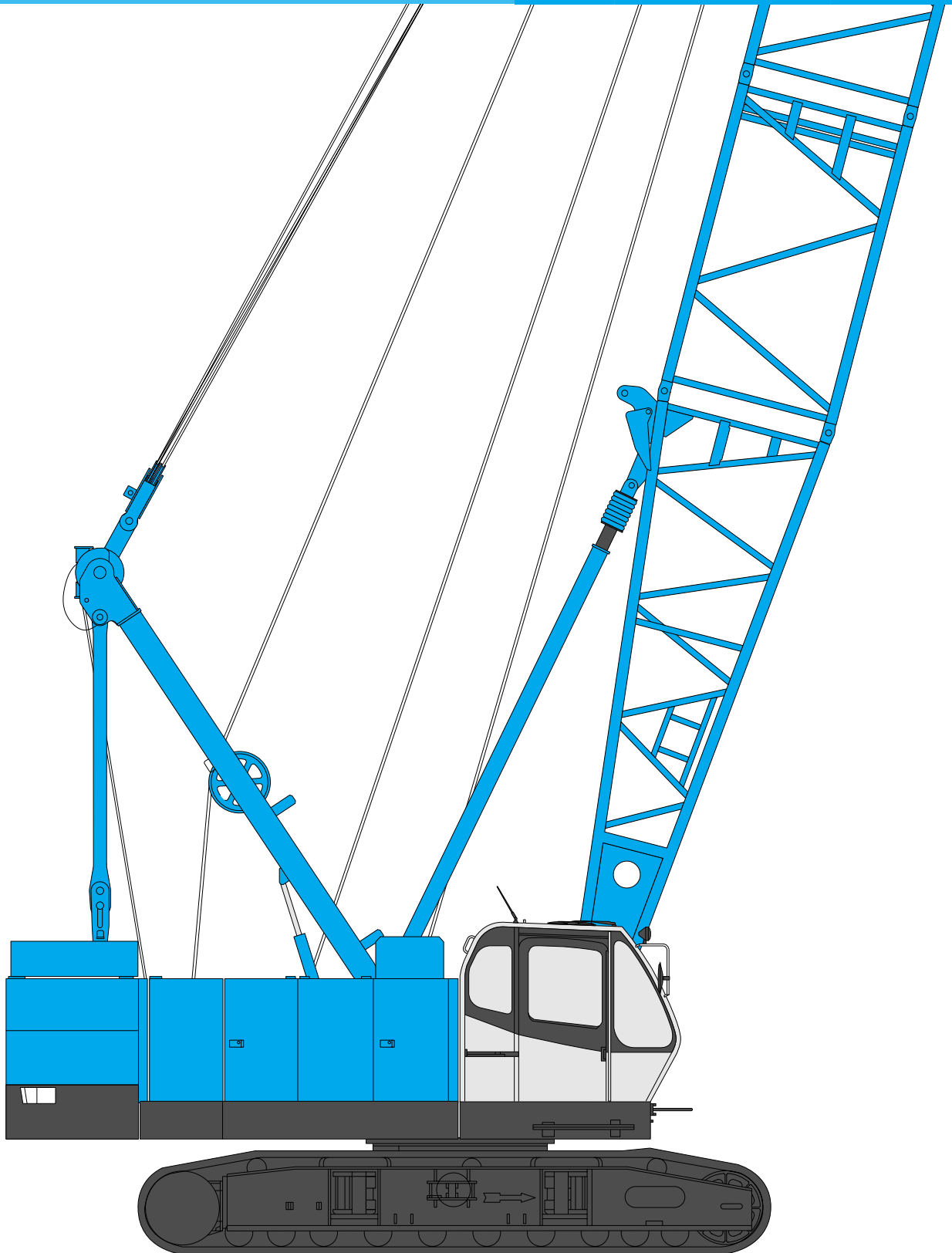

**Max. Lifting Capacity: 80 t x 3.7 m
Max. Crane Boom Length: 54.9 m**

CONFIGURATION

Crane Boom



Max. Lifting Capacity:
80 metric ton x 3.7 m
Max. Boom Length:
54.9 m

Clamshell

Max. Lifting Capacity:
10.0 metric ton x 16.0 m
Max. Boom Length:
24.4 m

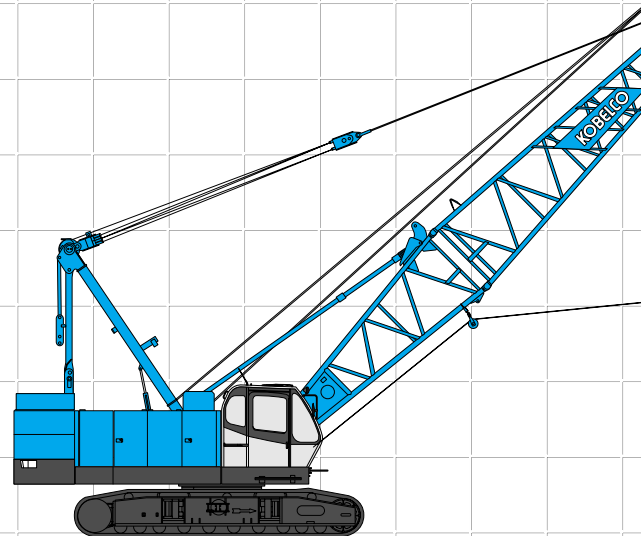
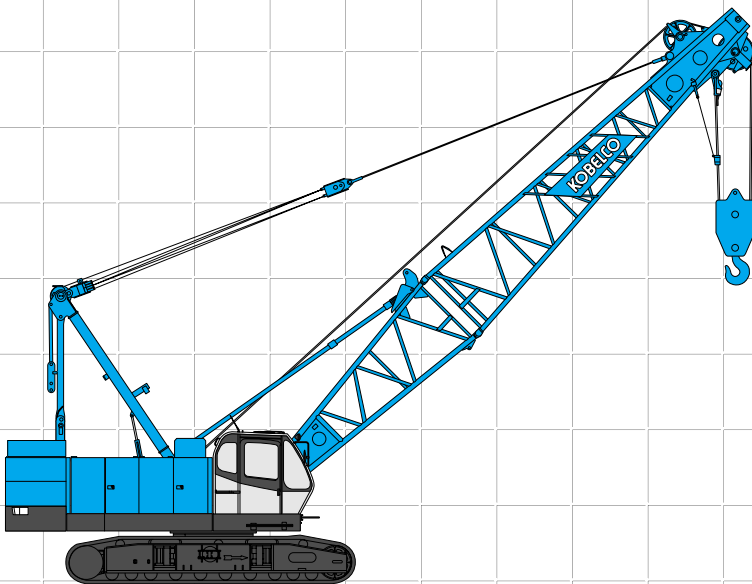

HEAVY DUTY BASE MACHINE FOR FOUNDATION WORK BM800 HD

Hammer Grab

Boom Length:

21.3 m

Lifting Capacity at 7.0 m:

36.1 ton

*Recommended Specification
for Casing Diameter: 2,000 mm

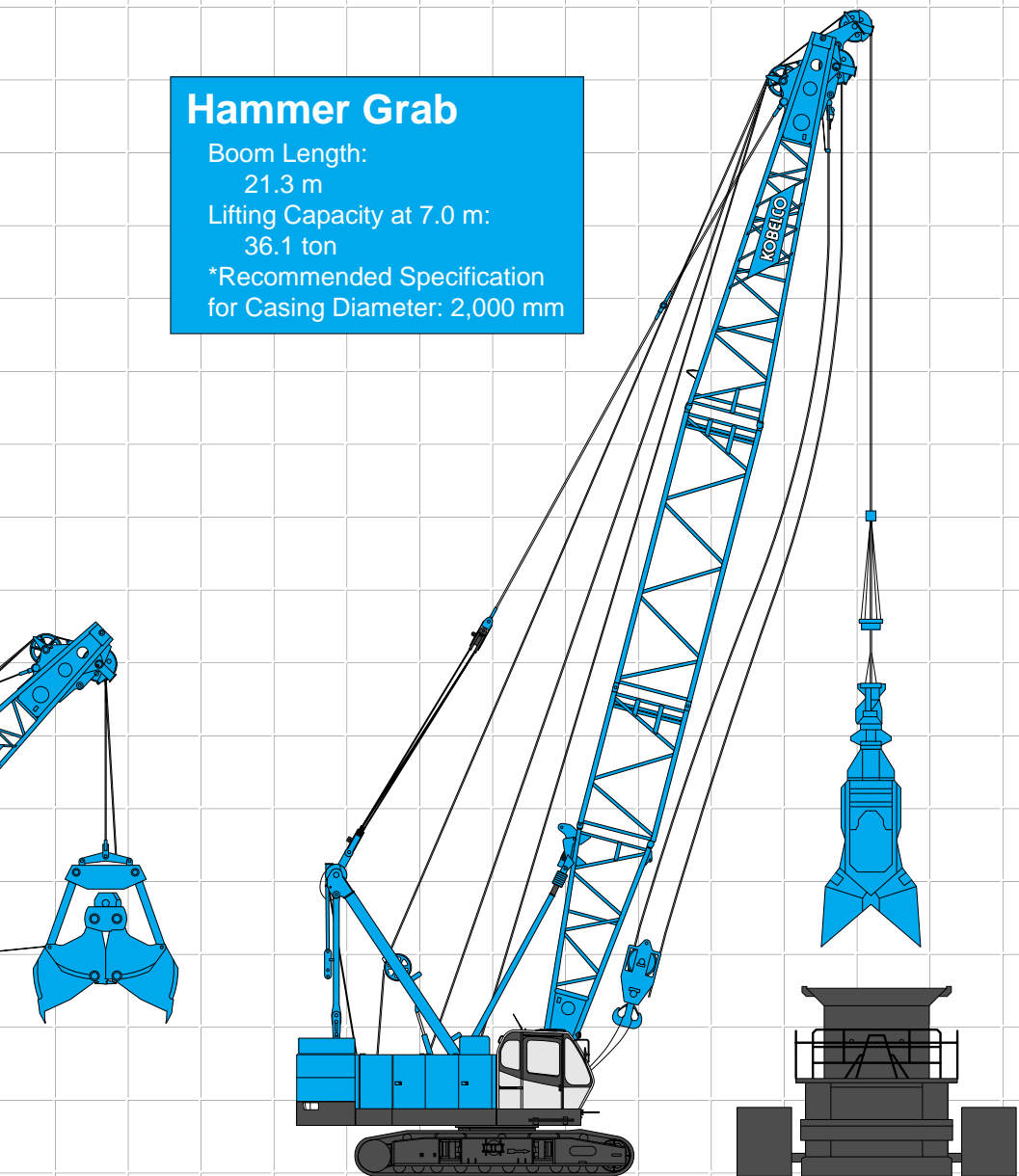

CONTENTS

Configuration 1

Specifications 3

General Dimensions 5

Boom Arrangements 6

Working Ranges and Lifting Capacities

Crane Boom
Working Ranges 8

Crane Boom
Lifting Capacity 9

Auxiliary Sheave
Lifting Capacity
for Crane Boom 10

Third Winch (Optional) 11

Clamshell 12

Parts and Attachments 13

SPECIFICATIONS



Power Plant

Model: Hino diesel engine P11C-UN
Type: Water-cooled, direct fuel injection, with turbocharger
Complies with NRMM (Europe) stage IIIA and US EPA Tier III
Displacement: 10.520 liters
Rated Power: 247 kW at 2,000 min⁻¹ {rpm} (ISO)
Max. torque: 1,300 N·m/1,500 min⁻¹
Cooling system: Liquid, recirculating bypass
Starter: 24 V/6.0 kW
Radiator: Corrugated type core, thermostatically controlled
Air cleaner: Dry type with replaceable paper element
Throttle: Electric throttle control, twist grip type
Fuel filter: Replaceable paper element
Batteries: Two 12V, 136 Ah/5HR capacity batteries, series connected.
Fuel tank capacity: 400 liters



Hydraulic System

Three variable displacement piston pumps are driven by heavy-duty pump drive. Two of variable displacement pumps are used in the main hook hoist circuit, boom hoist circuit, auxiliary hook hoist circuit and each propel circuit. The other is used in the swing circuit.

Control: Full-flow hydraulic control system for infinitely variable pressure to front and rear drums, boom hoist brakes and clutches. Controls respond instantly to the touch, delivering smooth function operation.

Cooling: Oil-to-air heat exchanger (plate-fin type)

Filtration: Full-flow and bypass type with replaceable element

Electrical system: All wiring corded for easy servicing, individual fused branch circuits.

Max. relief valve pressure:

Load hoist, boom hoist and propel system:

31.9 MPa {325 kgf/cm²}

Swing system: 27.5 MPa {280 kgf/cm²}

Control system: 7.0 MPa {71 kgf/cm²}

Reservoir capacity: 440 liters



Boom Hoisting System

Powered by a hydraulic motor through a planetary reducer.

Brake: A spring-set, hydraulically released multiple-disc brake is mounted on the boom hoist motor and operated through a counter-balance valve.

Drum lock: External ratchet for locking drum

Drum: Single drum, grooved for 18 mm dia. wire rope

Line speed: Single line on first drum layer

Hoisting, Lowering: 70 to 2 m/min

Diameter of wire ropes

Boom guy line: 30 mm

Boom hoist reeving: 12 parts of 18 mm dia. high strength wire rope

Boom backstops: Required for all boom lengths



Load Hoist System

Front and rear drums for load hoist powered by a hydraulic variable plunger motors, driven through planetary reducers.

Positive & Negative Brake: Forced-circulation oil-cooled wet-type multi-disc brake, each using positive and negative actuation. The drums are manually locked by the control cable. Both positive and negative brake systems are available in lever neutral position.

Drum lock: External ratchet for locking drum

Drums:

Front drum:

614 mm P.C.D. x 617 mm Lg. wide drum, grooved for 26 mm wire rope. Rope capacity is 170 m working length and 242 m storage length.

Rear drum:

614 mm P.C.D. x 617 mm Lg. wide drum, grooved for 26 mm wire rope. Rope capacity is 125 m working length and 242 m storage length.

Note: Rope lengths listed above denote drum capacity and may differ from actual rope lengths supplied when machinery is shipped.

Line speed: Single line on the first drum layer

Hoisting, Lowering: 120 to 3 m/min

Line Pull (Single-line):

Rated line pull: 108 kN {11 tf}

Max. line pull: 208 kN {21.2 tf} (1st layer)

Note: Max. line pull is theoretical values under certain test condition.



Swing System

Swing unit is powered by hydraulic motor driving spur gear through planetary reducer, the swing system provides 360° rotation.

Swing parking brakes: A spring-set, hydraulically released multiple-disc brake is mounted on swing motor.

Swing circle: Single-row ball bearing with an integral internally cut swing gear.

Swing lock: Manually, two position lock for transportation

Swing speed: 4.0 min⁻¹ {rpm}



Upper Structure

Torsion-free precision machined upper frame. All components are located clearly and service friendly. Engine with low noise level.

Counterweight: 25.8 ton

HYDRAULIC DOZER BASE MACHINE FOR FOUNDATION WORK

BM800 HD



Cab & Control

Totally enclosed, full vision cab with safety glass, fully adjustable, high backed seat with a head-rest and armrests, and intermittent wiper and window washer (skylight and front window).

Cab fittings:

Air conditioner, convenient compartment (for tool), cup holder, ashtray, cigarette lighter, sun visor, roof blind, tinted glass, floor mat, foot-rest, shoe tray

Controls:

Four adjustable levers for front drum, rear drum, boom drum and swing controls.



Lower Structure

Steel-welded carbody with axles. Crawler assemblies can be hydraulically extended for wide-track operation or retracted for transportation. Crawler belt tension is maintained by hydraulic jack force on the track-adjusting bearing block.

Crawler drive: Independent hydraulic propel drive is built into each crawler side frame. Each drive consists of a hydraulic motor propelling a driving tumbler through a planetary gear box. Hydraulic motor and gear box are built into the crawler side frame within the shoe width.

Crawler brakes: Spring-set, hydraulically released parking brakes are built into each propel drive.

Steering mechanism: A hydraulic propel system provides both skid steering (driving one track only) and counter-rotating steering (driving each track in opposite directions).

Track rollers: Sealed track rollers for maintenance-free operation.

Shoes (flat): 63 shoes, 800 mm wide each crawler

Max. travel speed: 1.5/1.0 km/h

Max. gradeability: 30%



Weight

Including upper and lower machine, 25.8 ton counterweight, basic boom, hook, and other accessories.

Specification

Weight

Ground pressure

Crane boom

Approx. 75 ton,

82 kPa {0.84 kgf/cm²}



Attachment

Boom

Welded lattice construction using tubular, high-tensile steel chords with pin connections between sections.

Boom Length

	Crane Boom
Basic Boom	12.2 m
Max. Boom	54.9 m

Main Specifications (Model: BM800HD-2F)

Crane Boom	
Max. Lifting Capacity	80 t/3.7 m
Max. Length	54.9 m
Main & Aux. Winch	
Max. Line Speed	120 m/min (1st layer)
Rated Line Pull (Single-line)	108 kN {11.0 tf}
Max. line pull (Single-line)***	208 kN {21.2 tf} (1st layer)
Wire Rope Diameter	26 mm
Wire Rope Length	170 m (Main) 125 m (Aux.)
Brake Type	Forced-circulation oil-cooled wet-type multi-disc brake (Positive & Negative)
Working Speed	
Swing Speed	4.0 min ⁻¹ {rpm}
Travel Speed	1.9/1.2 km/h
Power Plant	
Model	Hino P11C-UN
Engine Output	247 kW/2,000 min ⁻¹
Fuel Tank Capacity	400 liters

Hydraulic System	
Main Pumps	3 variable displacement
Max. Pressure	31.9 MPa {325 kgf/cm ² }
Hydraulic Tank Capacity	440 liters
Weight	
Operating Weight*	Approx. 75 t
Ground Pressure*	82 kPa {0.84 kgf/cm ² }
Counterweight	25.8 t
Transport Weight**	Approx. 44.8 t

Units are SI units. { } indicates conventional units.

* Including upper and lower machine, 25.8 ton counterweight, basic boom, hook and other accessories.

** Base machine with gantry, crawlers, wire ropes for main and boom hoist winches and lower spreader (Refer to notes P13).

*** Max. line pull is theoretical values under certain test condition.

GENERAL DIMENSIONS

Crane Boom

(Unit: mm)

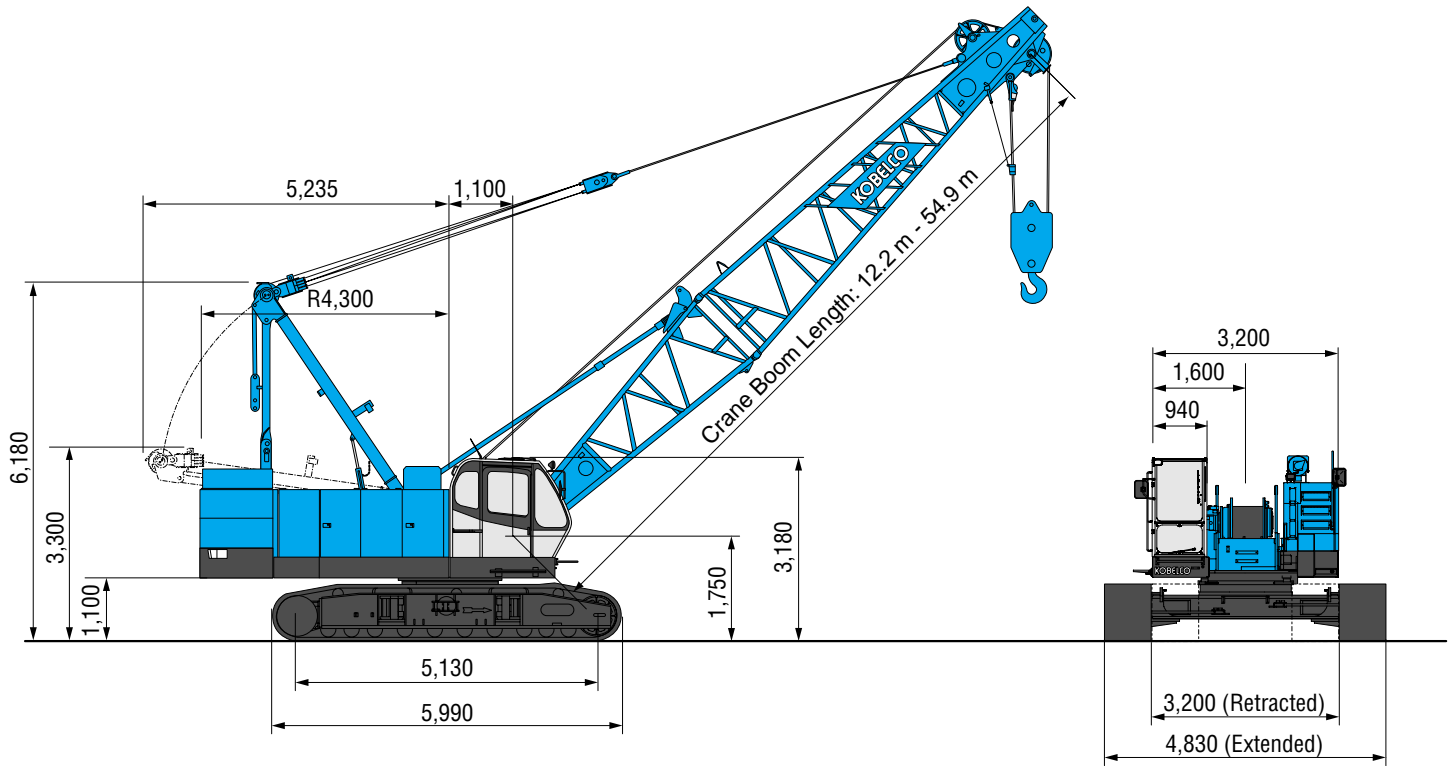



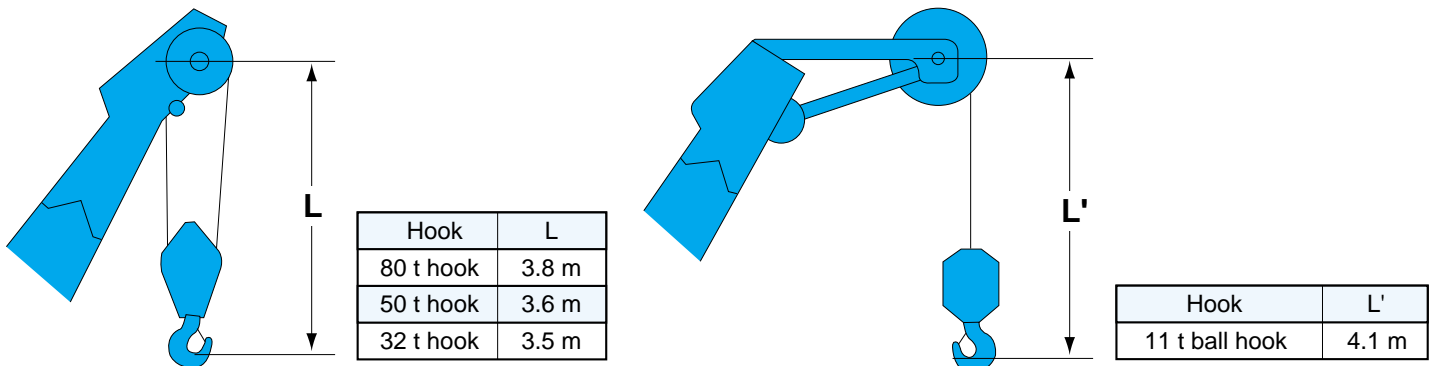

Limit of Hook Lifting





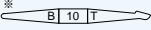
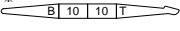
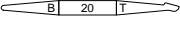
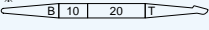
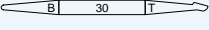
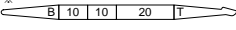
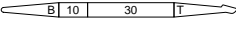
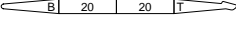
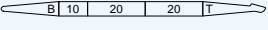

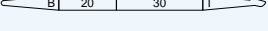
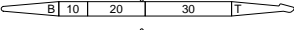

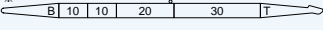
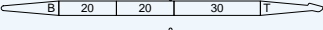
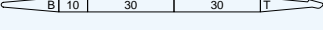
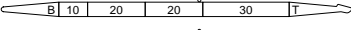
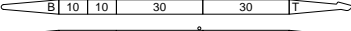
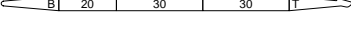

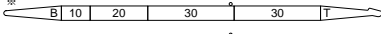
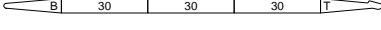
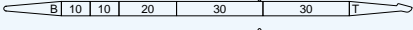
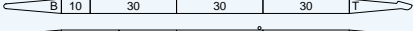
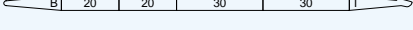

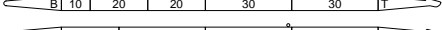
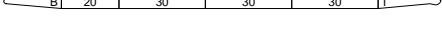
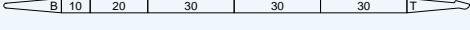
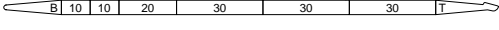
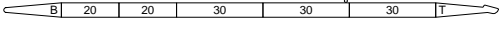
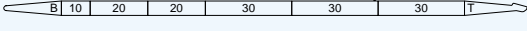
BOOM ARRANGEMENTS

TRAVEL DOLLY BASE MACHINE FOR FOUNDATION WORK

BM800 HD

Boom length m (ft)	Boom arrangement
12.2 (40)	
15.2 (50)	
18.3 (60)	 
21.3 (70)	 
24.4 (80)	  
27.4 (90)	  
30.5 (100)	 
33.5 (110)	  
36.6 (120)	  

Boom length m (ft)	Boom arrangement
39.6 (130)	 
42.7 (140)	  
45.7 (150)	  
48.8 (160)	
51.8 (170)	 
54.9 (180)	

Symbol	Boom Length	Remarks
	5.2 m	Boom Base
	7.0 m	Boom Top
	3.0 m	Insert Boom
	6.1 m	Insert Boom
	9.1 m	Insert Boom
	6.1 m	Insert Boom with Lug
	9.1 m	Insert Boom with Lug

※ mark shows the standard boom arrangement which enables each boom length of less than that boom length to be configured.

Note: A 6.1 m a 9.1 m insert boom with lug is required when assembling a boom length of 39.6 m or over without using an auxiliary crane.



Hook Blocks

A range of hook blocks can be specified, each with a safety latch.

Hooks	Weight (kg)	No. of sheaves	No. of lines and max. rated loads (tons)							
			1	2	3	4	5	6	7	8
80-ton	950	4	-	-	-	44.0	55.0	66.0	77.0	80.0
50-ton	700	3	-	22.0	33.0	44.0	50.0	-	-	-
32-ton	550	1	-	22.0	32.0	-	-	-	-	-
11-ton ball hook	300	0	11.0	-	-	-	-	-	-	-

Symbols for Attachments:



Crane Boom

Auxiliary Sheave
for Crane Boom

WORKING RANGES AND LIFTING CAPACITIES

Crane Boom Working Ranges

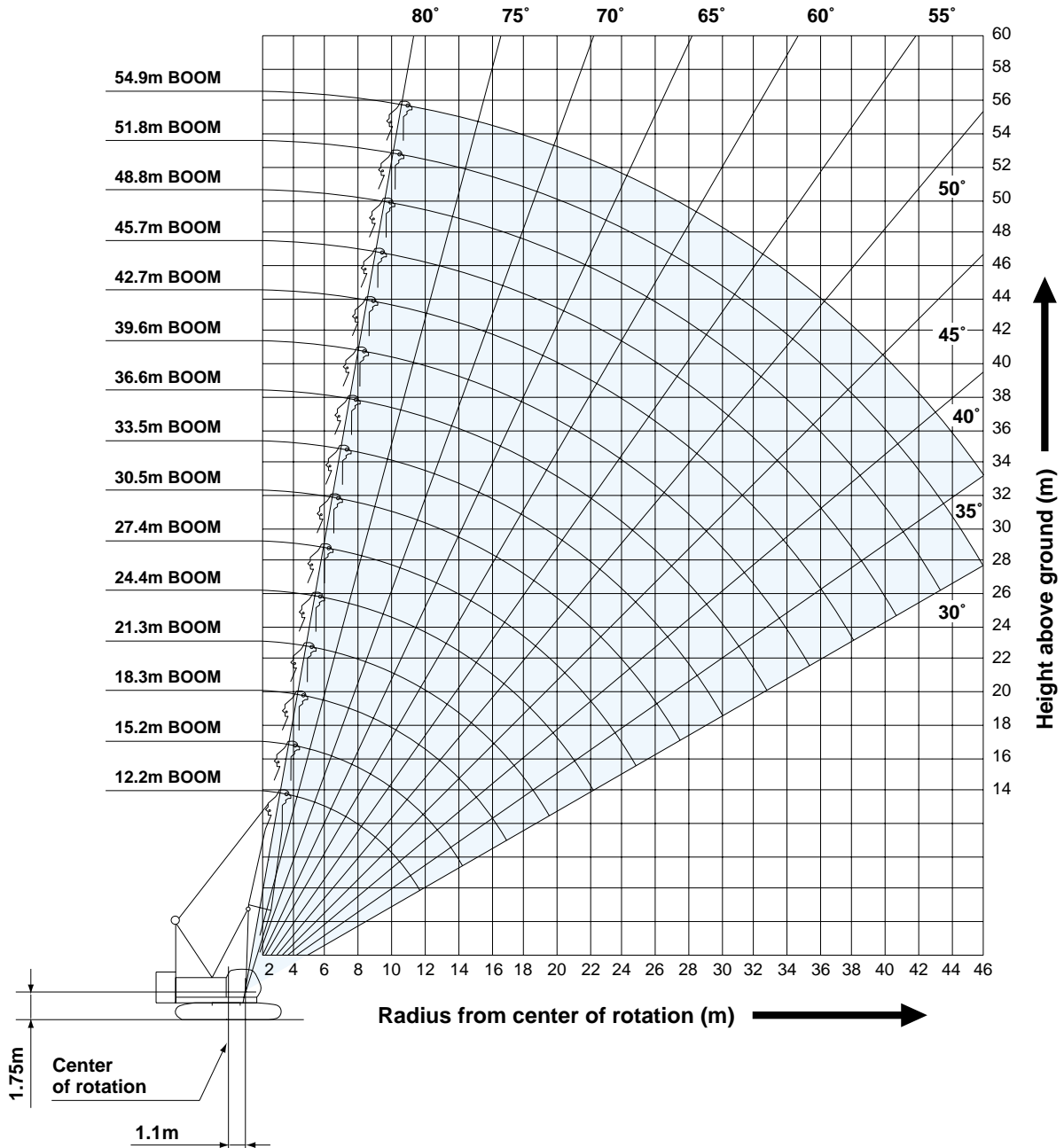

NOTES:

1. Ratings according to Japanese Construction Codes for Mobile Cranes and Japanese Safety Ordinance on Cranes, etc.
2. Ratings in metric tons for 360° working area.
3. Operating radius is the horizontal distance from center of rotation to a vertical line through the center of gravity of the load.
4. Weight of hook block(s), slings and other load handling accessories are included in rated load. Their total weight must be subtracted from rated load to obtain weight that can be lifted.
5. Ratings shown are based on freely suspended loads and make no allowance for such factors as wind effect on lifted load, ground conditions, out-of-level, operating speeds or any other condition that could be detrimental to the safe operation of this equipment. Operator, therefore, has the responsibility to judge the existing conditions and reduce lifted loads and operating speeds accordingly.
6. Ratings are for operation on a firm and level surface.
7. At radii and boom lengths where no ratings are shown on chart, operation is not intended nor approved.
8. Boom inserts and guy lines must be arranged as shown in the "Operator's Manual".
9. Boom hoist reeving is 12 part line.
10. Gantry must be in raised position for all conditions.
11. Boom backstops are required for all boom lengths.
12. Crawler frames must be fully extended for all crane operations.
13. Ratings shown in are determined by the strength of the boom or other structural component.
14. Instruction in the "Operator's Manual" must be strictly observed when operating the machine.
15. Crane boom ratings: Deduct weight of main hook block, slings, and all other load handling accessories from crane boom ratings shown.
16. Auxiliary sheave ratings for crane boom: Deduct weight of ball hook, slings, and all other load handling accessories from auxiliary sheave ratings for crane boom shown.
17. Crane boom lengths for auxiliary sheave mounting are 12.2 m to 51.8 m.



Crane Boom Lifting Capacity

Unit: metric ton

Counterweight: 25.8 t

Working radius (m)	Boom Length (m)		12.2	15.2	18.3	21.3	24.4	27.4	30.5	33.5	36.6	39.6	42.7	45.7	48.8	Boom Length (m)	
	Working radius (m)	Working radius (m)														Working radius (m)	Working radius (m)
3.7	80.0																3.7
4.0	70.5	4.3m/64.2	4.8m/57.2														4.0
5.0	56.5	56.4	56.3	5.3m/51.2	5.9m/45.9												5.0
6.0	45.7	45.6	45.5	45.5	45.4	6.4m/41.1	6.9m/36.5										6.0
7.0	36.3	36.2	36.1	36.1	36.0	35.9	35.8	7.5m/32.4									7.0
8.0	30.0	29.9	29.8	29.7	29.6	29.6	29.4	29.4	29.3	8.5m/26.7							8.0
9.0	25.5	25.4	25.3	25.2	25.1	25.0	24.9	24.9	24.8	24.7	22.0	9.6m/19.9					9.0
10.0	22.2	22.0	21.9	21.9	21.7	21.7	21.5	21.5	21.4	21.3	21.2	18.7	10.1m/17.7				10.0
12.0	11.8m/15.9	17.3	17.2	17.1	17.0	16.9	16.8	16.7	16.6	16.5	16.5	16.4	16.2				12.0
14.0		14.1	14.1	14.0	13.8	13.8	13.6	13.6	13.4	13.3	13.3	13.2	13.1				14.0
16.0		14.5m/13.0	11.9	11.8	11.6	11.5	11.4	11.3	11.2	11.1	11.0	10.9	10.8				16.0
18.0			17.1m/10.7	10.1	9.9	9.9	9.7	9.7	9.5	9.4	9.3	9.2	9.1				18.0
20.0				19.8m/9.0	8.6	8.6	8.4	8.3	8.2	8.1	8.0	7.9	7.8				20.0
22.0					7.6	7.5	7.4	7.3	7.2	7.0	7.0	6.9	6.7				22.0
24.0					22.4m/7.5	6.7	6.5	6.5	6.3	6.2	6.1	6.0	5.9				24.0
26.0						25.0m/6.3	5.8	5.8	5.6	5.5	5.4	5.3	5.1				26.0
28.0							27.7m/5.3	5.2	5.0	4.9	4.8	4.7	4.5				28.0
30.0								4.7	4.5	4.4	4.3	4.2	4.0				30.0
32.0								30.3m/4.6	4.1	3.9	3.8	3.7	3.6				32.0
34.0									33.0m/3.9	3.6	3.5	3.3	3.2				34.0
36.0										35.6m/3.3	3.1	3.0	2.9				36.0
38.0											2.8	2.7	2.5				38.0
40.0											38.2m/2.8	2.4	2.2				40.0
42.0												40.9m/2.3	2.0				42.0
44.0													43.5m/1.8				44.0
46.0																	46.0
Reeves	8	6	6	5	5	4	4	3	3	3	2	2	2				Reeves

Working radius (m)	Boom Length (m)		10.0
	Working radius (m)	Working radius (m)	
10.0	10.6m/16.3	11.2m/13.2	10.0
12.0	13.5	13.2	12.0
14.0	12.9	12.8	14.0
16.0	10.7	10.6	16.0
18.0	9.0	8.9	18.0
20.0	7.7	7.5	20.0
22.0	6.6	6.5	22.0
24.0	5.8	5.6	24.0
26.0	5.0	4.9	26.0
28.0	4.4	4.3	28.0
30.0	3.9	3.8	30.0
32.0	3.5	3.3	32.0
34.0	3.1	2.9	34.0
36.0	2.7	2.5	36.0
38.0	2.4	2.2	38.0
40.0	2.1	1.9	40.0
42.0	1.8	1.6	42.0
44.0	1.5	1.3	44.0
46.0	1.3	1.1	46.0
Reeves	2	2	Reeves

Note:
 Ratings according to Japanese Construction Codes for Mobile Cranes and Japanese Safety Ordinance on Cranes, etc.
 Ratings shown in are determined by the strength of the boom or other structural components.
 Refer to notes P8.



HEAVY DUTY BASE MACHINE FOR FOUNDATION WORK BM800 HD

Auxiliary Sheave Lifting Capacity for Crane Boom (With 32 t Main Hook)

Unit: metric ton

Counterweight: 25.8 t

Working radius (m) \ Boom Length (m)	12.2	15.2	18.3	21.3	24.4	27.4	30.5	33.5	36.6	39.6	42.7	45.7	Working radius (m) \ Boom Length (m)
4.0	4.2m/11.0	4.7m/11.0											4.0
5.0	11.0	11.0	5.2m/11.0	5.7m/11.0									5.0
6.0	11.0	11.0	11.0	11.0	6.3m/11.0	6.8m/11.0							6.0
7.0	11.0	11.0	11.0	11.0	11.0	11.0	7.3m/11.0	7.8m/11.0					7.0
8.0	11.0	11.0	11.0	11.0	11.0	11.0	11.0	11.0	8.4m/11.0	8.9m/11.0			8.0
9.0	11.0	11.0	11.0	11.0	11.0	11.0	11.0	11.0	11.0	11.0	9.4m/11.0		9.0
10.0	11.0	11.0	11.0	11.0	11.0	11.0	11.0	11.0	11.0	11.0	11.0	11.0	10.0
12.0	12.7m/11.0	11.0	11.0	11.0	11.0	11.0	11.0	11.0	11.0	11.0	11.0	11.0	12.0
14.0		11.0	11.0	11.0	11.0	11.0	11.0	11.0	11.0	11.0	11.0	11.0	14.0
16.0		15.3m/11.0	11.0	11.0	10.9	10.8	10.7	10.6	10.5	10.4	10.3	10.2	16.0
18.0			9.5	9.4	9.3	9.2	9.0	8.9	8.8	8.7	8.6	8.5	18.0
20.0				8.1	7.9	7.9	7.7	7.6	7.5	7.4	7.3	7.2	20.0
22.0				20.6m/7.7	6.9	6.8	6.7	6.6	6.4	6.3	6.2	6.1	22.0
24.0					23.2m/6.3	6.0	5.8	5.7	5.6	5.5	5.3	5.2	24.0
26.0						25.9m/5.3	5.1	5.0	4.9	4.8	4.6	4.5	26.0
28.0							4.5	4.4	4.3	4.2	4.0	3.9	28.0
30.0							28.5m/4.4	3.9	3.8	3.6	3.5	3.4	30.0
32.0								31.2m/3.6	3.3	3.2	3.1	3.0	32.0
34.0									33.8m/2.9	2.8	2.7	2.6	34.0
36.0										2.5	2.3	2.2	36.0
38.0										36.4m/2.4	2.0	1.9	38.0
40.0											39.1m/1.8	1.6	40.0
42.0												41.7m/1.3	42.0
Reeves													Reeves

Working radius (m) \ Boom Length (m)	48.8	51.8	Working radius (m) \ Boom Length (m)
10.0	10.5m/11.0	11.0m/11.0	10.0
12.0	11.0	11.0	12.0
14.0	11.0	11.0	14.0
16.0	10.0	9.9	16.0
18.0	8.3	8.2	18.0
20.0	7.0	6.9	20.0
22.0	6.0	5.9	22.0
24.0	5.1	5.0	24.0
26.0	4.4	4.3	26.0
28.0	3.8	3.7	28.0
30.0	3.3	3.2	30.0
32.0	2.8	2.7	32.0
34.0	2.4	2.3	34.0
36.0	2.1	1.9	36.0
38.0	1.7	1.6	38.0
40.0	1.4	1.2	40.0
42.0	1.1		42.0
Reeves			Reeves

Note:

Ratings according to Japanese Construction Codes for Mobile Cranes and Japanese Safety Ordinance on Cranes, etc.

Refer to notes P8.

THIRD WINCH (Optional)

Crane Boom Lifting Capacity (With Optional Third Winch)

Unit: metric ton

Counterweight: 25.8 t

Working radius (m)	Boom Length (m)											Working radius (m)
	12.2	15.2	18.3	21.3	24.4	27.4	30.5	33.5	36.6	39.6	42.7	
3.7	44.0											3.7
4.0	44.0	4.3m/44.0	4.8m/44.0									4.0
5.0	44.0	44.0	44.0	5.3m/44.0	5.9m/44.0							5.0
6.0	44.0	44.0	44.0	44.0	44.0	6.4m/41.1	6.9m/33.0					6.0
7.0	36.3	36.2	36.1	36.1	36.0	35.9	33.0	7.5m/32.4				7.0
8.0	30.0	29.9	29.8	29.7	29.6	29.6	29.4	29.4	22.0	8.5m/22.0		8.0
9.0	25.5	25.4	25.3	25.2	25.1	25.0	24.9	24.9	22.0	22.0	22.0	9.0
10.0	22.2	22.0	21.9	21.9	21.7	21.7	21.5	21.5	21.4	21.3	21.2	10.0
12.0	11.8m/15.9	17.3	17.2	17.1	17.0	16.9	16.8	16.7	16.6	16.5	16.5	12.0
14.0		14.1	14.1	14.0	13.8	13.8	13.6	13.6	13.4	13.3	13.3	14.0
16.0		14.5m/13.0	11.9	11.8	11.6	11.5	11.4	11.3	11.2	11.1	11.0	16.0
18.0			17.1m/10.7	10.1	9.9	9.9	9.7	9.7	9.5	9.4	9.3	18.0
20.0				19.8m/9.0	8.6	8.6	8.4	8.3	8.2	8.1	8.0	20.0
22.0					7.6	7.5	7.4	7.3	7.2	7.0	7.0	22.0
24.0					22.4m/7.5	6.7	6.5	6.5	6.3	6.2	6.1	24.0
26.0						25.0m/6.3	5.8	5.8	5.6	5.5	5.4	26.0
28.0							27.7m/5.3	5.2	5.0	4.9	4.8	28.0
30.0								4.7	4.5	4.4	4.3	30.0
32.0								30.3m/4.6	4.1	3.9	3.8	32.0
34.0									33.0m/3.9	3.6	3.5	34.0
36.0										35.6m/3.3	3.1	36.0
38.0											2.8	38.0
40.0											38.2m/2.8	40.0

Note:

- Applicable notes are fundamentally the same as those for notes p8.
- Please follow the data in the table below for number of lines for use with hooks. Failure to follow this data may result in the boom rising and tipping backwards during hook hoisting.

No. of lines and max. rated loads

Hooks	Weight (kg)	No. of sheaves	No. of lines and max. rated loads (tons)			
			1	2	3	4
50-ton	700	3	-	22.0	33.0	44.0
32-ton	550	1	-	22.0	32.0	-
11-ton ball hook	300	0	11.0	-	-	-

Boom lengths and no. of parts of line

compatible with use of third winch (with 145 m wire rope)

		Boom Length (m)										
		12.2	15.2	18.3	21.3	24.4	27.4	30.5	33.5	36.6	39.6	42.7
No. of lines	4	○	○	○	○	○	○	-	-	-	-	-
	3	○	○	○	○	○	○	○	○	-	-	-
	2	×	○	○	○	○	○	○	○	○	○	○
	1	×	×	×	×	○	○	○	○	○	○	○

○ : Available × : Not available (Limited by the stability of the boom)
 - : Not available (Limited by the length of the wire rope)

CLAMSHELL

HYDRA DOB BASE MACHINE FOR FOUNDATION WORK BM800 HD

Working Ranges

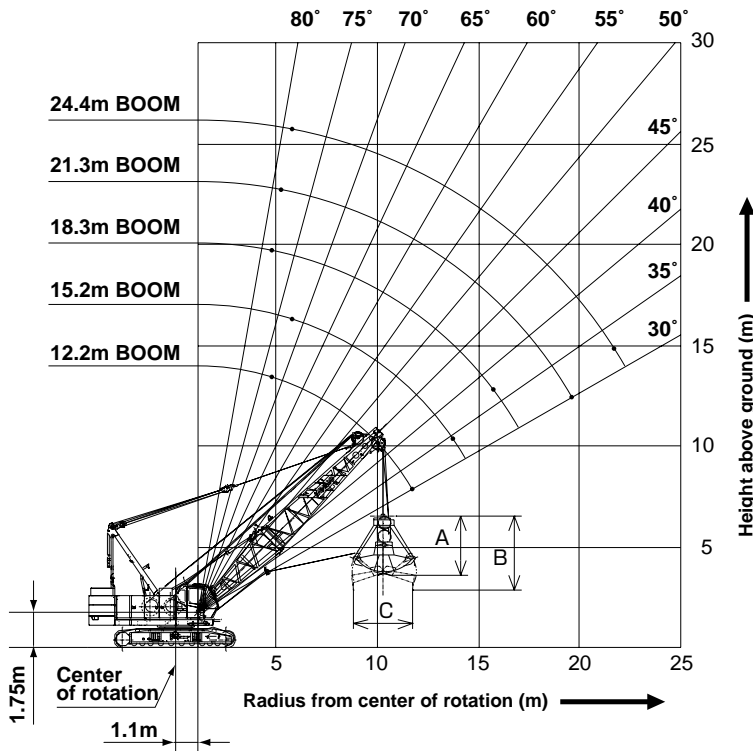

Clamshell Bucket Specification (For Reference only)

Bucket Capacity (m³)	Bucket Weight (t)	Dimension (m)			Use
		A	B	C	
1.6	3.2	3.3	3.6	3.0	Loading
2.0	3.8	3.5	3.9	3.1	Loading
1.25	3.6	2.9	3.7	3.0	Digging
1.6	4.6	3.2	4.0	3.2	Digging

Note:

- Working radius is the horizontal distance between the center of rotation and the bucket's center of gravity.
- Total weight of bucket and materials must not exceed rated load.
- Optimal bucket should be required according to material.
 $\text{Bucket capacity (m}^3\text{)} \times \text{Specified gravity of material (ton/m}^3\text{)} + \text{Bucket weight (ton)} = \text{Rated load}$
 Material: sand, gravel, lime (apparent specific gravity: approx. 1 to 1.8)
 Ex.) Bucket capacity: 2.0 m³, Bucket weight 3.8 tons
 $2.0 \text{ m}^3 \times 1.8 + 3.8 \text{ tons} = 7.4 \text{ tons}$
- Bucket weight must also be decreased according to operating cycle and bucket lowering height.
- Rated loads are determined by stability and boom strength. During simultaneous operations of boom and swing, rapid acceleration or deceleration must be avoided. Particular care is required with long boom length.

Clamshell Bucket Lifting Capacity

When digging or when handling materials that generate a horizontal pulling load

Unit: metric ton

Counterweight: 25.8 t

Working radius (m)	Boom Length (m)					Working radius (m)
	12.2	15.2	18.3	21.3	24.4	
5.0	7.5		7.5			5.0
5.5	7.5		7.5	7.5		5.5
6.0	7.5	7.5	7.5	7.5	7.4	6.0
7.0	7.5	7.5	7.5	7.5	7.4	7.0
8.0	7.5	7.5	7.5	7.5	7.4	8.0
9.0	7.5	7.5	7.5	7.5	7.4	9.0
10.0	7.5	7.5	7.5	7.5	7.1	10.0
12.0	7.5	7.5	7.5	7.2	6.8	12.0
14.0		7.5	7.5	7.0	6.5	14.0
16.0			7.5	6.8	6.2	16.0
18.0				6.5	5.9	18.0
20.0				6.2	5.6	20.0
22.0					5.3	22.0

When handling materials that do not generate a horizontal pulling load

Unit: metric ton

Counterweight: 25.8 t

Working radius (m)	Boom Length (m)					Working radius (m)
	12.2	15.2	18.3	21.3	24.4	
5.0	10.0		10.0			5.0
5.5	10.0		10.0	10.0		5.5
6.0	10.0	10.0	10.0	10.0	9.8	6.0
7.0	10.0	10.0	10.0	10.0	9.8	7.0
8.0	10.0	10.0	10.0	10.0	9.8	8.0
9.0	10.0	10.0	10.0	10.0	9.8	9.0
10.0	10.0	10.0	10.0	10.0	9.4	10.0
12.0	10.0	10.0	10.0	9.6	9.0	12.0
14.0		10.0	10.0	9.3	8.6	14.0
16.0			10.0	9.0	8.2	16.0
18.0				8.1	7.8	18.0
20.0				7.0	6.9	20.0
22.0					6.1	22.0

PARTS AND ATTACHMENTS

Base Machine

With lower boom, gantry and crawler, wire ropes for main and boom hoist winches, lower spreader and upper spreader
Weight: 46,400 kg Width: 3,200 mm

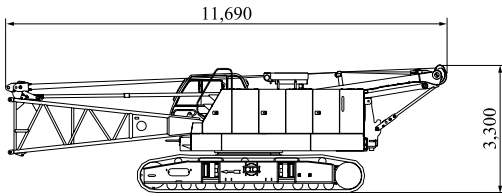

Base Machine

With gantry, crawlers, wire ropes for main and boom hoist winches and lower spreader
Weight: 44,800 kg Width: 3,200 mm

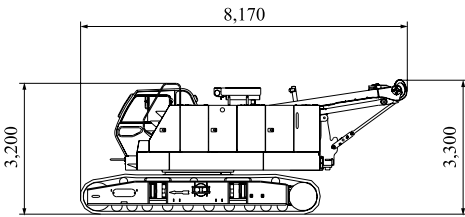

Crawler

Weight: 7,000 kg

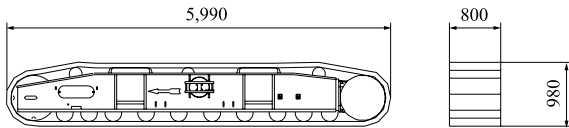

Boom Base

Weight: 1,130 kg

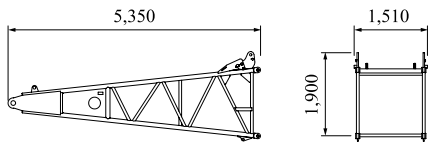

Boom Top

Weight: 1,420 kg (with boom guy cables)

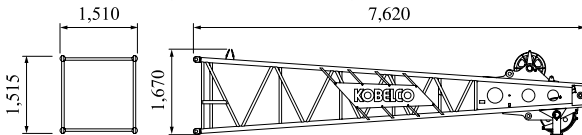

Counterweight A

Weight: 7,650 kg

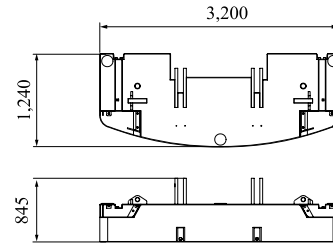

Counterweight B

Weight: 7,560 kg

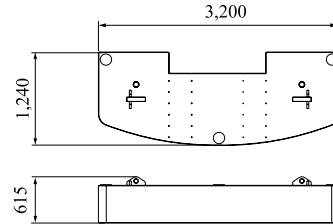

Counterweight C

Weight: 7,560 kg

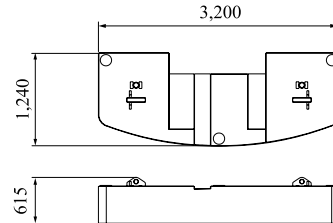

Counterweight D

Weight: 1,500 kg

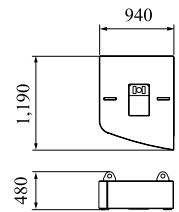

Counterweight E

Weight: 1,500 kg

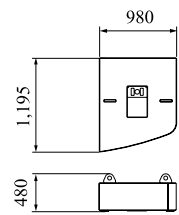

Dimensions: mm Weight: kg

Insert Boom

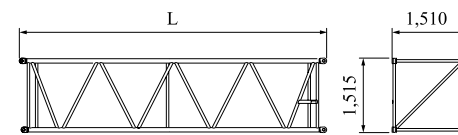

	L (mm)	Weight (kg)*
3.0m	3,160	370
6.1m	6,210	610
9.1m	9,260	850

*with boom guy cables

Other Attachments

Attachments	Weight	Dimensions (L x W x H)
6.1 m insert boom with lug	630 kg (with guy cables)	6,210 mm x 1,510 mm x 1,645 mm
9.1 m insert boom with lug	870 kg (with guy cables)	9,260 mm x 1,510 mm x 1,645 mm
Auxiliary sheave	330 kg	1,445 mm x 960 mm x 945 mm
Trans-lifter	350 kg (1 piece)	1,180 mm x 320 mm x 960 mm
Crane backstop	97.5 kg (1 piece)	4,400 mm x 114 mm dia. (x 2 pieces)
Upper spreader	280 kg	1,580 mm x 300 mm x 680 mm
80-ton hook	950 kg	700 mm x 455 mm x 1,825 mm
50-ton hook	700 kg	700 mm x 370 mm x 1,700 mm
32-ton hook	550 kg	700 mm x 365 mm x 1,570 mm
11-ton ball hook	300 kg	360 mm dia x 1,050 mm

Note: Estimated weights may vary $\pm 2\%$.



**HEAVY DUTY BASE MACHINE
FOR FOUNDATION WORK**
BM800HD

Standard Equipment

Upper structure/Lower structure

Counterweight: 25.8 ton (total weight)
800 mm shoe crawlers
Batteries (136 Ah/5 HR)
Gantry raising/lowering cylinder
Electric hand throttle grip
Variable boom hoist speed controller
Variable main/aux. hoist speed controller
Side deck for cab
Steps (crawlers)
Two front working lights
Two rear view mirrors
Tools (for routine maintenance)
Upper spreader storage guide

Cab Control

Air conditioner
Luggage box
Cup holder
Ashtray
Cigar lighter
Intermittent wiper & window washer (skylight and front window)
Sun visor
Roof blind
Floor mat (cloth)
Foot rest
Shoe tray

Safety Device

Load Moment Indicator (with boom lowering slow stop function)
LMI release key (for hook over-hoist prevention device and boom over-hoist prevention device)
LCD multi display
Ultimate stop function for boom over-hoist
Function lock lever
Propel lever lock
Mechanical drum lock pawl (main, aux. and boom hoist)
Signal horn
Swing parking brake
Mechanical swing lock pin (two positions)
Swing flashers/warning buzzer

Note: Standard equipment may vary depending on your areas or countries.
Due to our policy of continual product improvements all designs and specifications are subject to change without advance notice.
Copyright by KOBELCO CRANES CO., LTD. No part of this catalog may be reproduced in any manner without notice.

KOBELCO CRANES CO., LTD.

17-1, Higashigotanda 2-chome, Shinagawa-ku, Tokyo 141-8626 JAPAN
Tel: +81-3-5789-2130 Fax: +81-3-5789-3372

KOBELCO is the corporate mark used by Kobe Steel on a variety of products and in the names of a number of Kobe Steel Group companies.

Inquiries To: